

MM 015 4x3 19mm

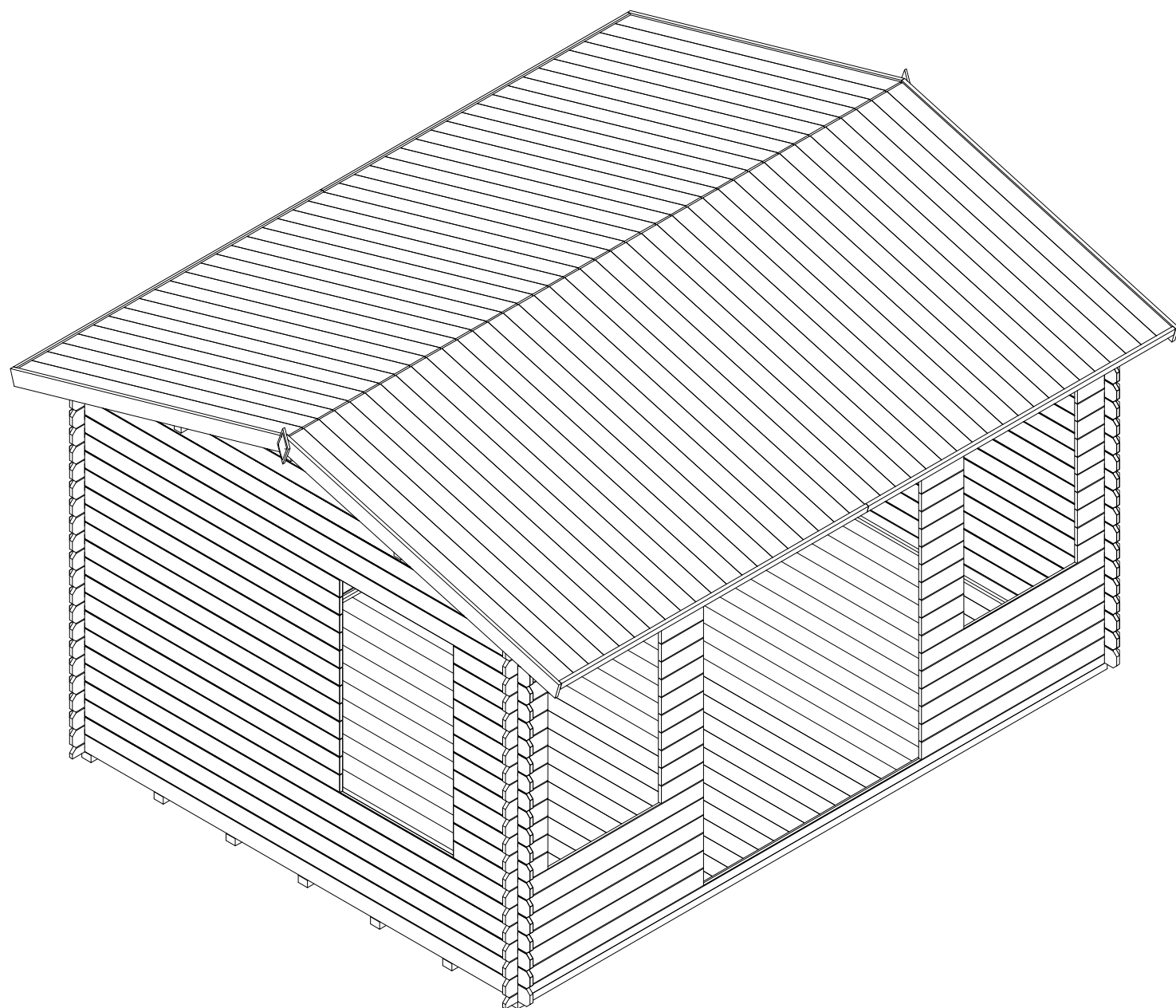

MM 015 4x3 19mm

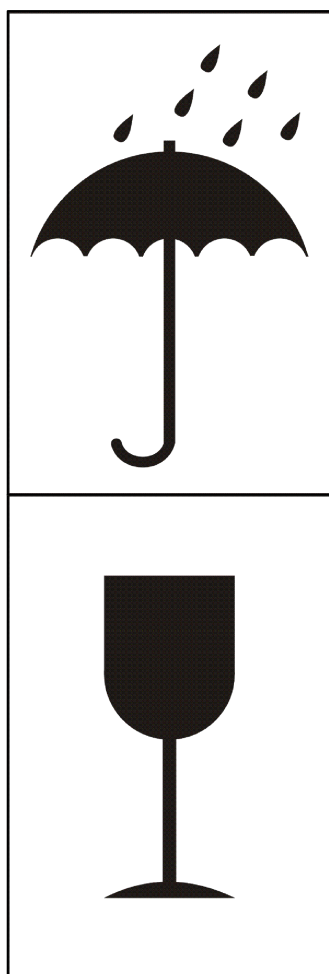

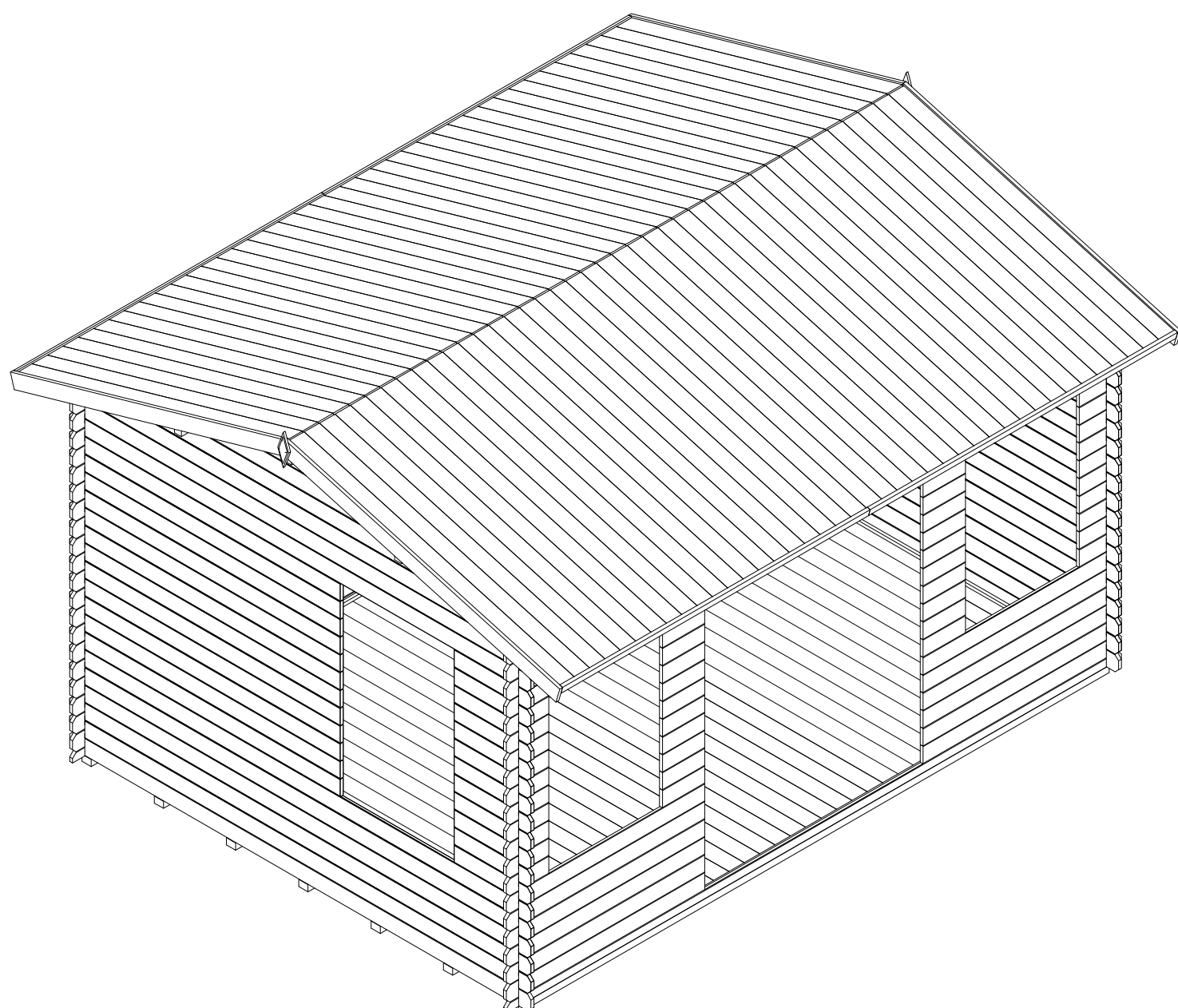
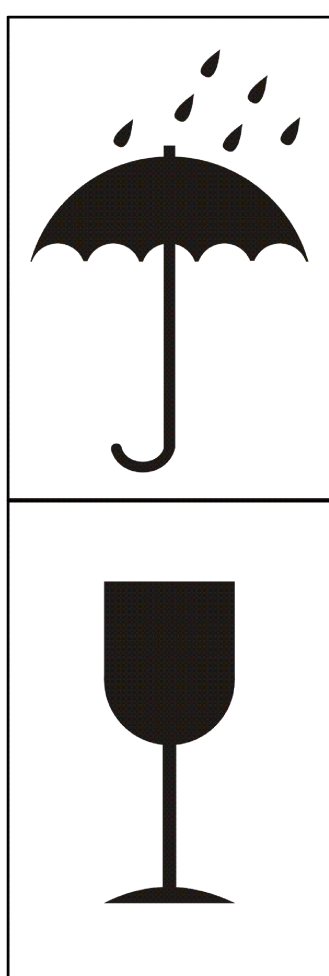







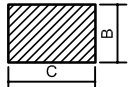
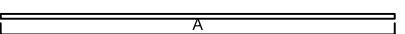
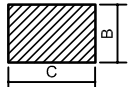
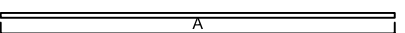
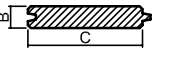
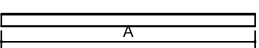
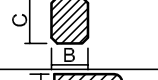
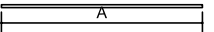
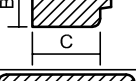
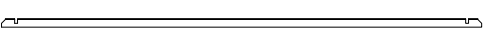
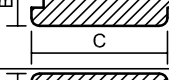
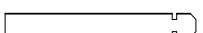
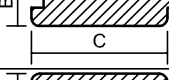

MM 015 4x3 19mm

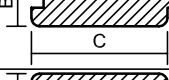
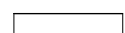
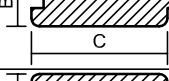
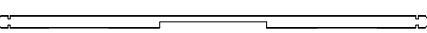
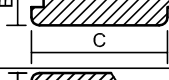
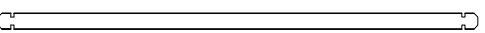
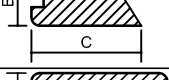
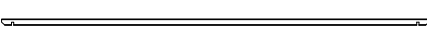
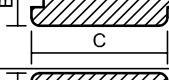
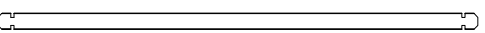
MM 015 4x3

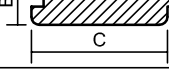
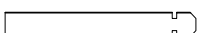
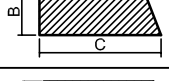
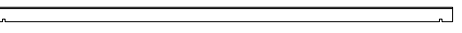
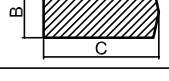
400x300 cm
19 mm 2015.06.05

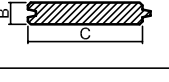
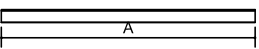
BE 2015

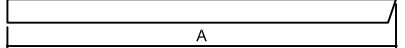
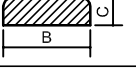
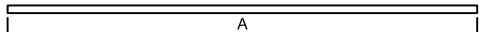
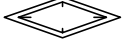
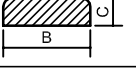
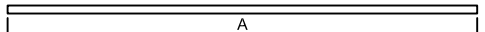
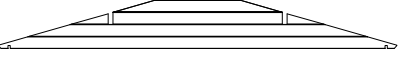
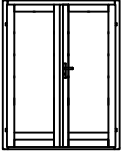
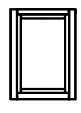
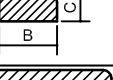
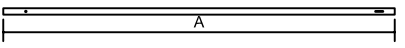
-Date-

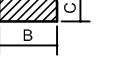
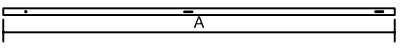
Degree <74°	Dimensions, mm			Pos.	Quantity	
	A	B	C			
		3720	40	60	1	7
		2840	40	60	1a	2
		2792	19	100/86	2	38/45
			19	24	3	~ 27 meters
		4000	19	50	4	2
		1290	19	100	5	12
		275	19	100	6	24
		275	19	100	7	24
		4000	19	100	8	1
		4000	19	100	9	21
		4000	19	50	10	2
		3000	19	100	11	28
		1760	19	100	12	12
		500	19	100	13	12
		4000	40	110	14	2
		4000	40	110	15	1
		1830	19	100/86	16	80/94
		1857	19	90	17	4
		2000	19	40	18	4
		200	100		19	2
		1857	19	40	20	4
		3000	494		F-2,4	2
		1420	1850		21	1
		740	1200		22	3
		1880	19	40	23	4
		300	19	100	F	6 Banging blocks
		1880	19	40	24	6

-Packing No.-

-Name-lastname-

-Signature-

Log MM 015

400x300 cm

19 mm 2015.06.05

BE 2015

3.5x35 mm

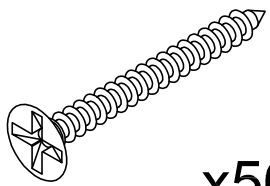

x56

5x70 mm

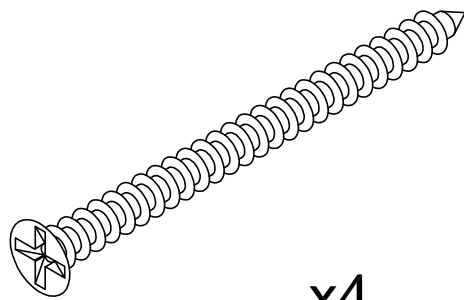

x4

5x100 mm

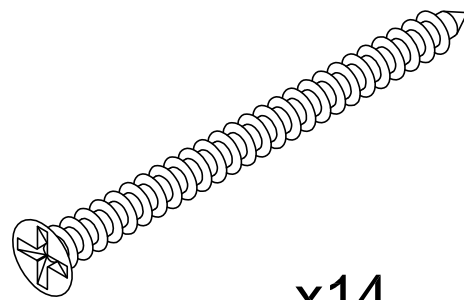

x14

5x120 mm

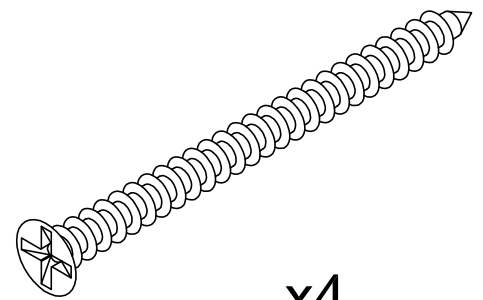

x4

8x60 mm

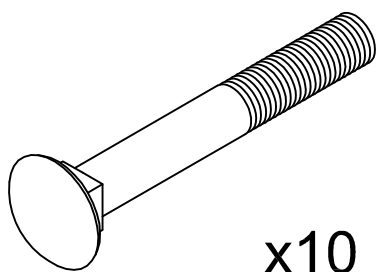

x10

M8

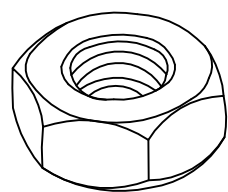

x10

M8

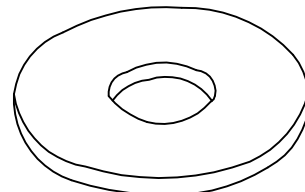

x10

3 mm

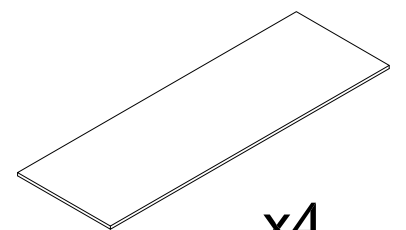

x4

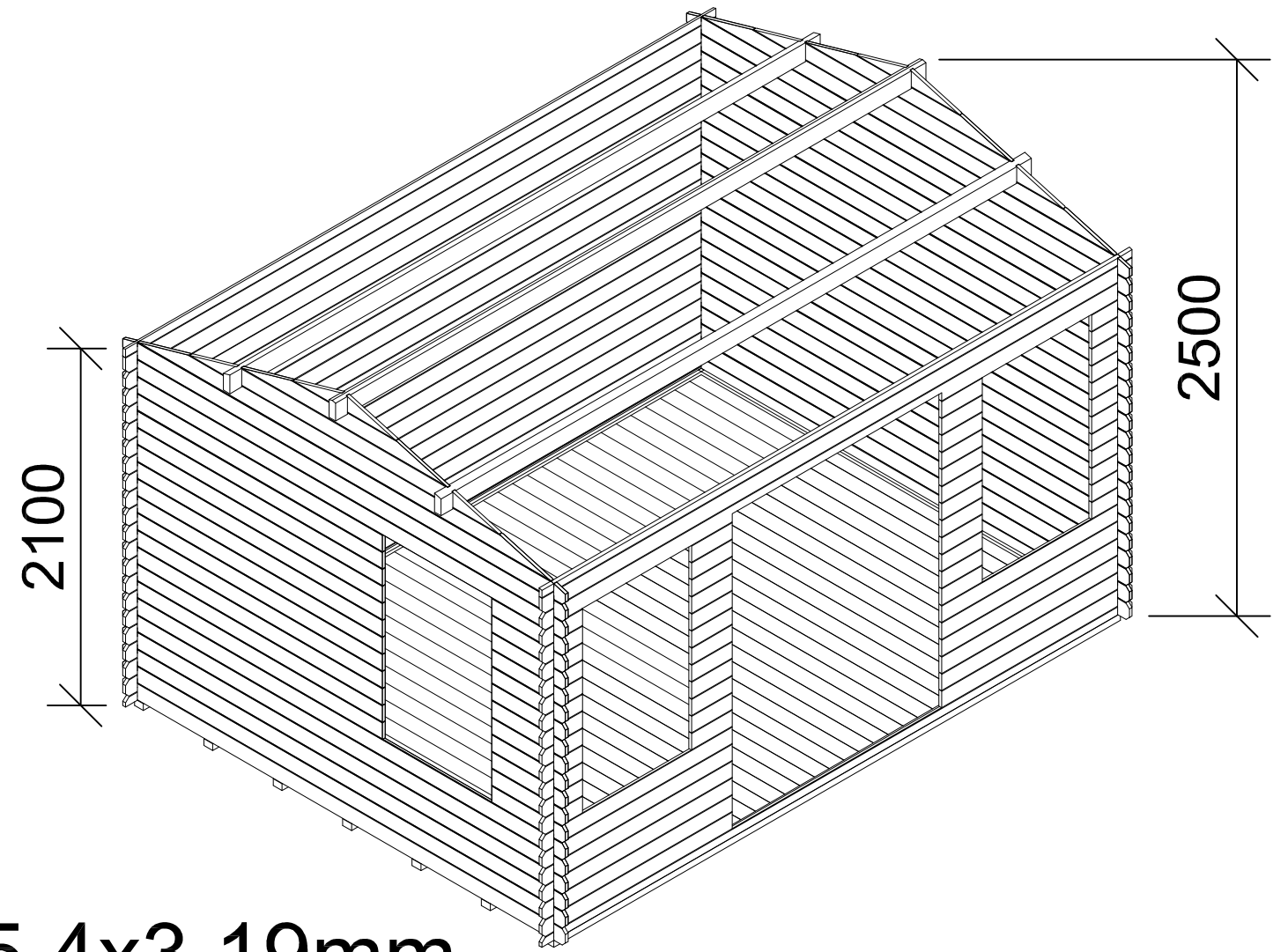
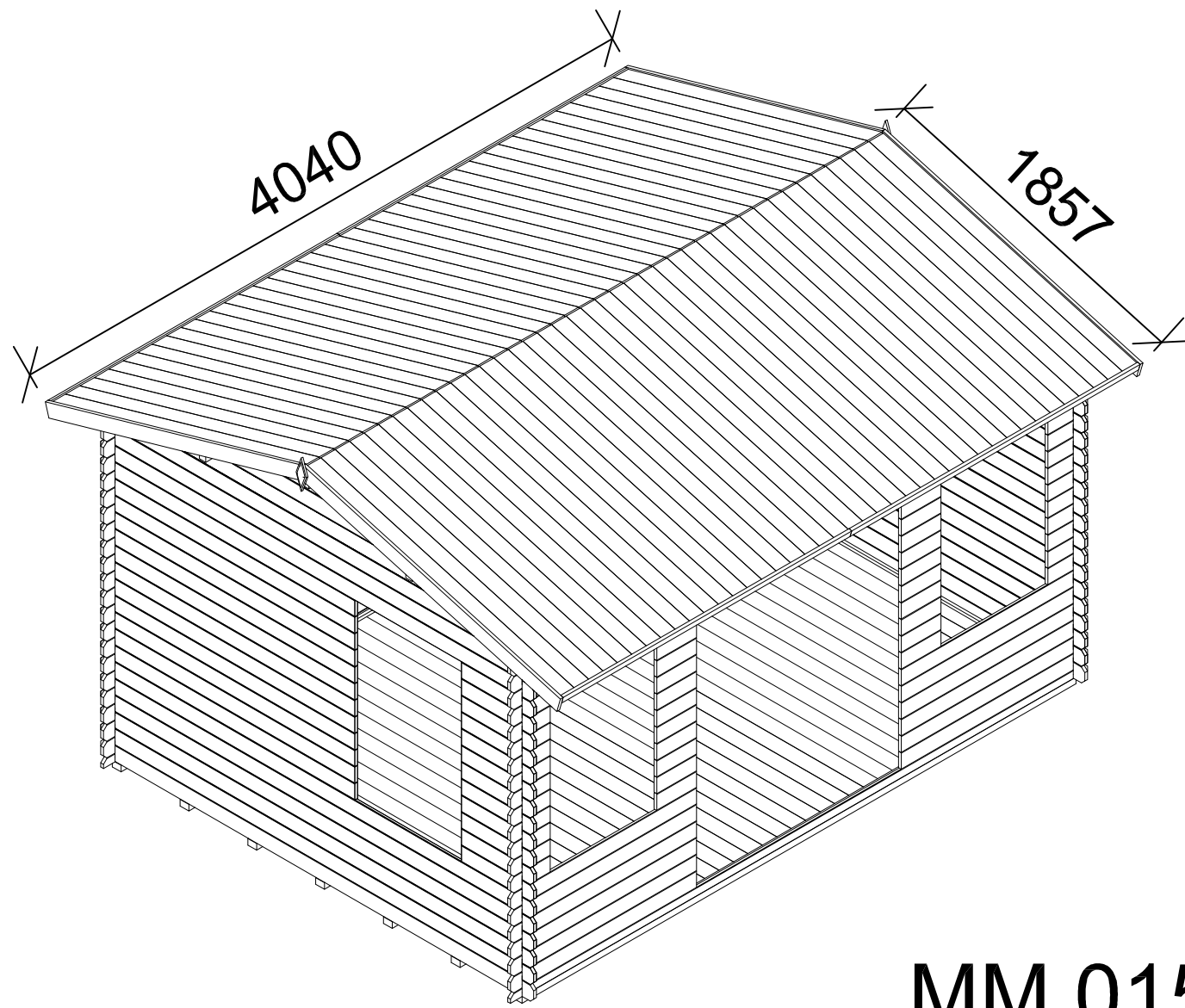

MM 015 4x3 19mm

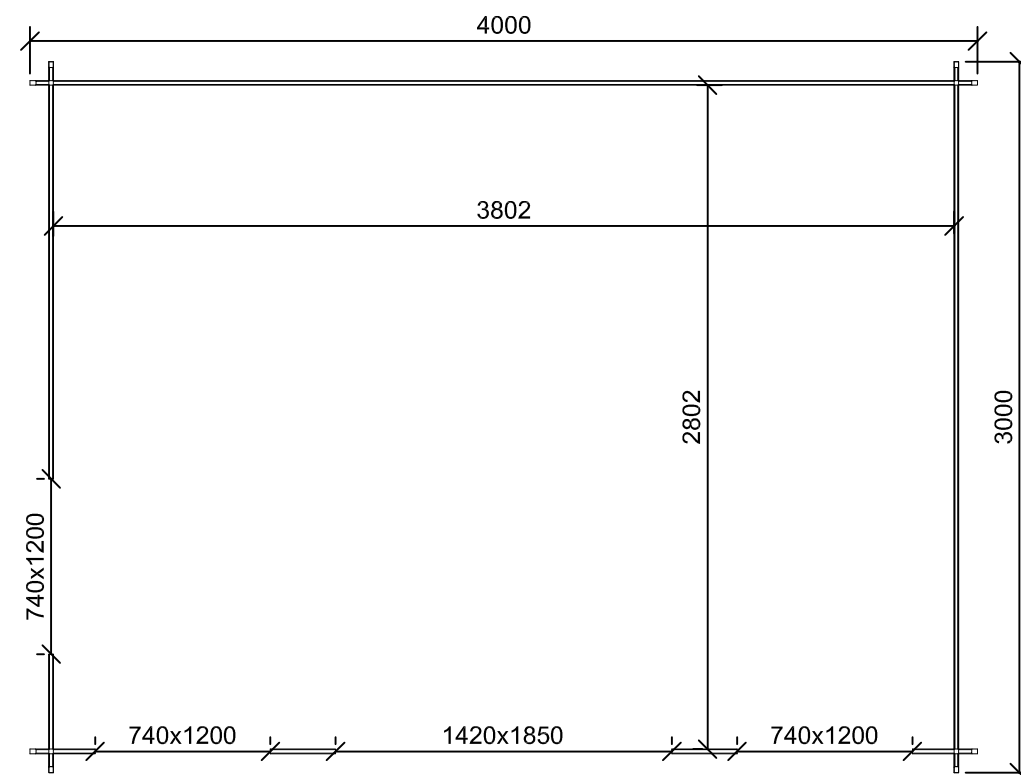
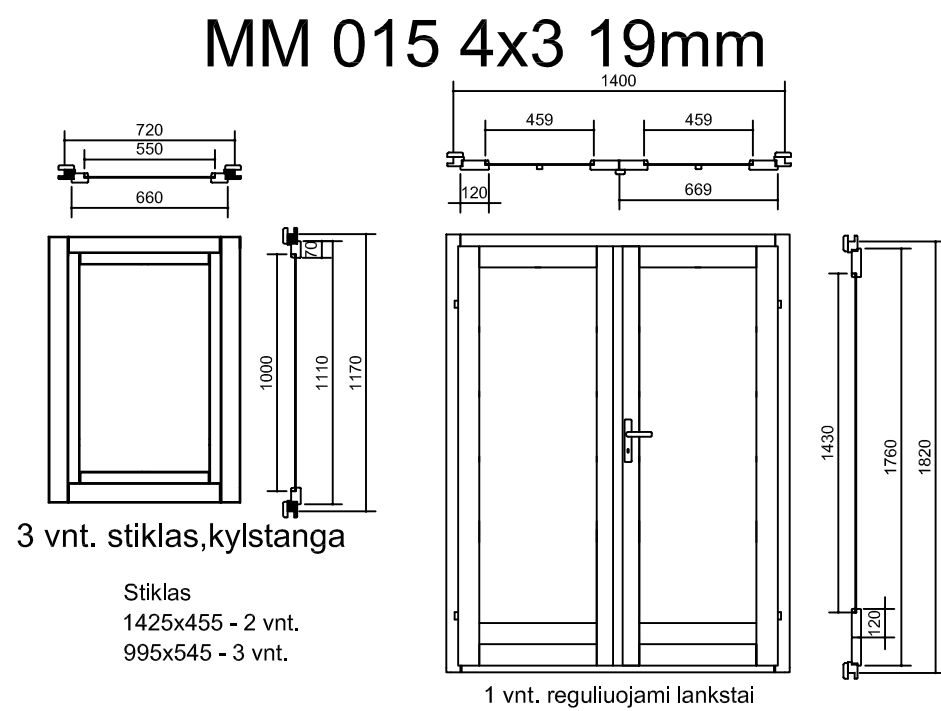

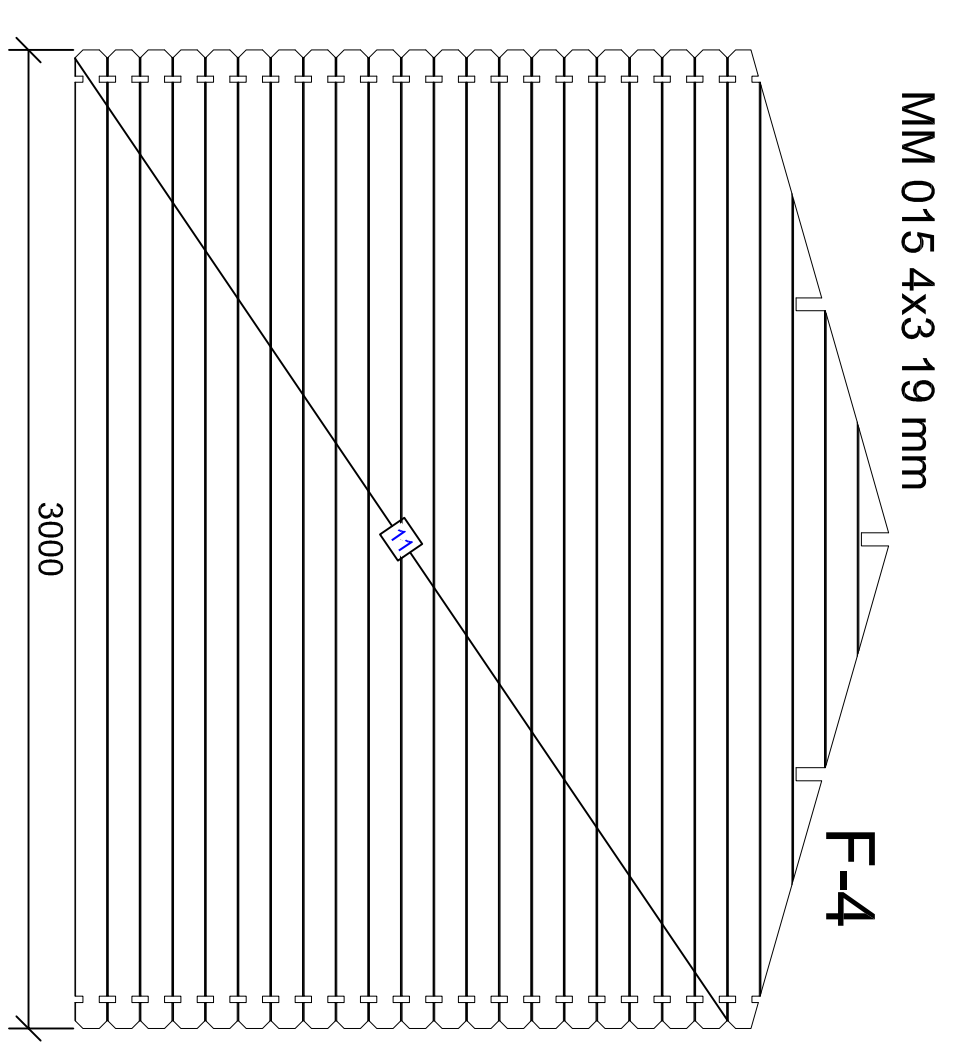
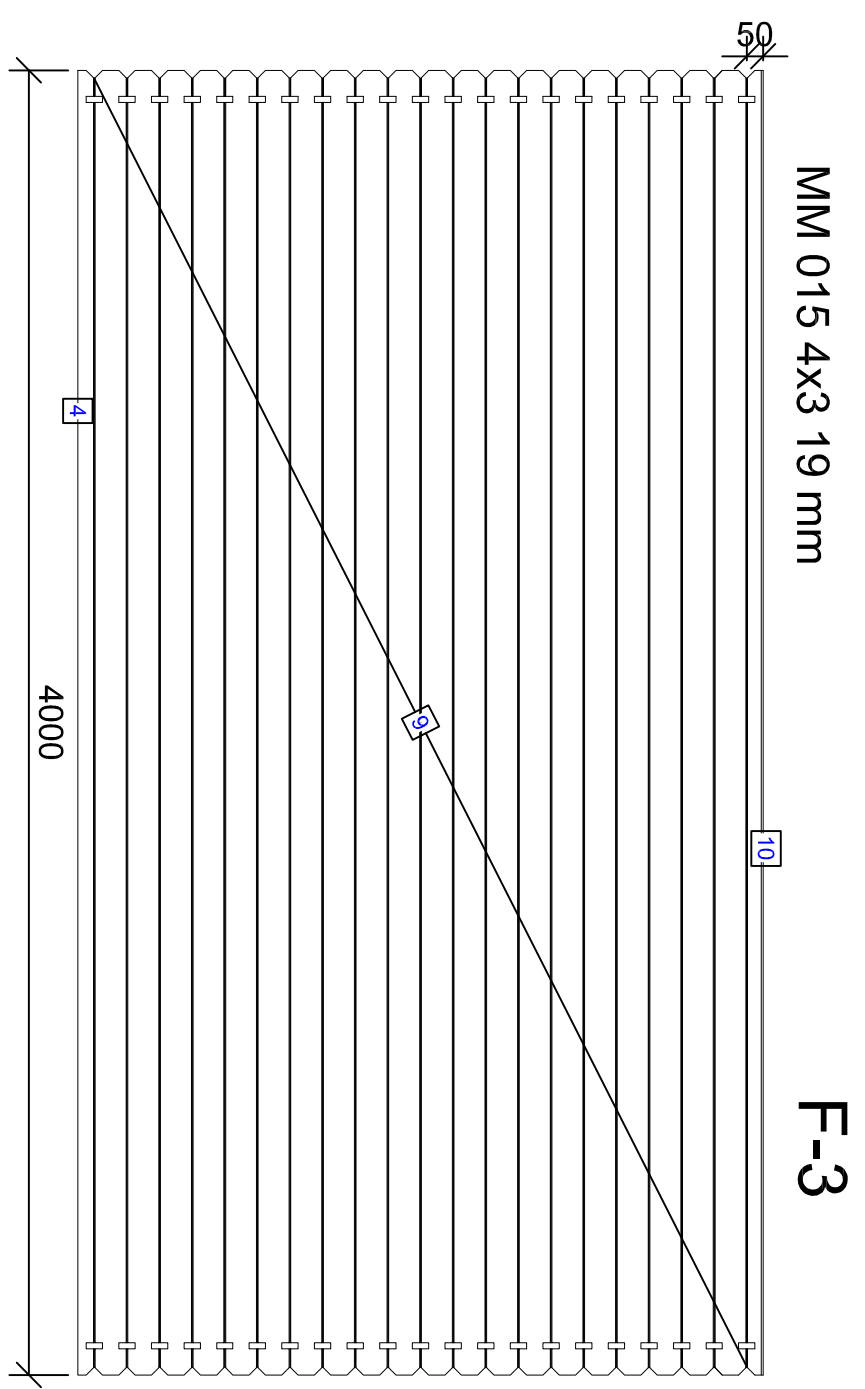
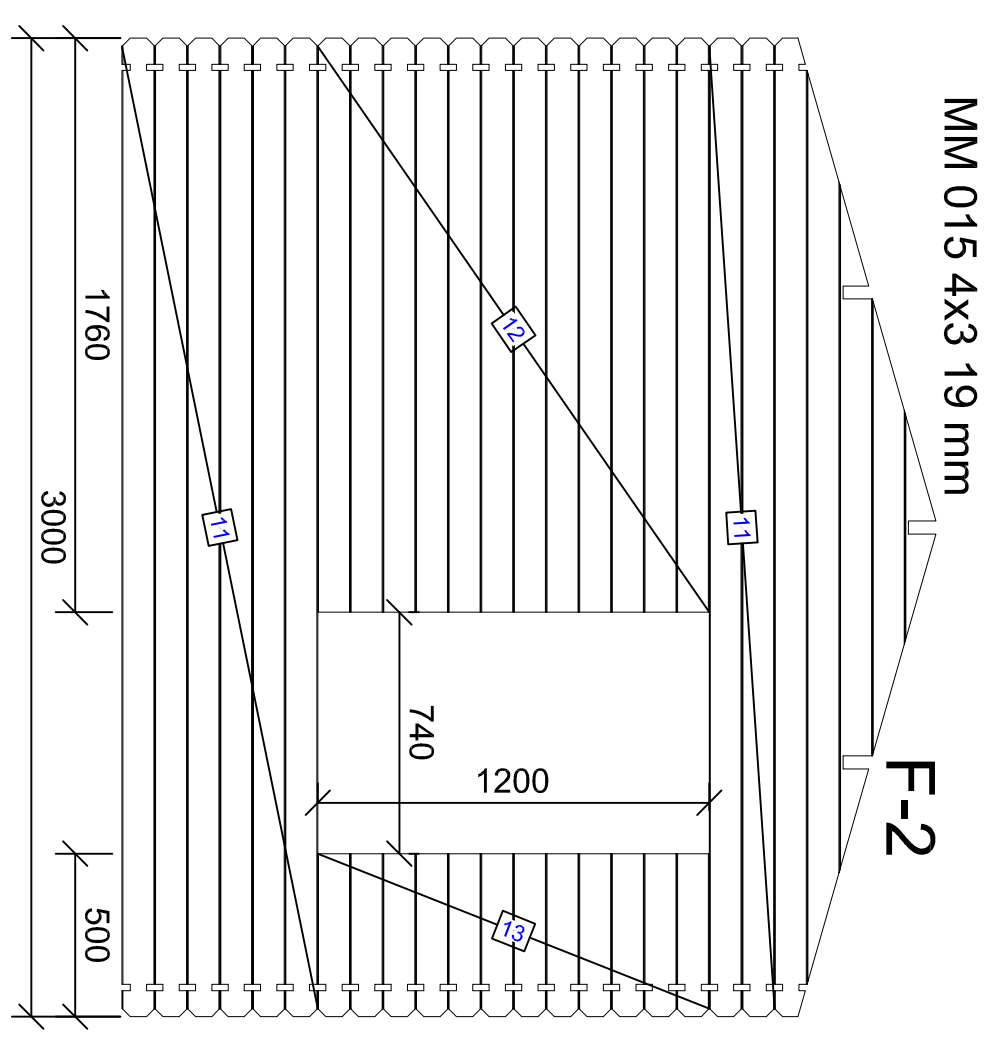
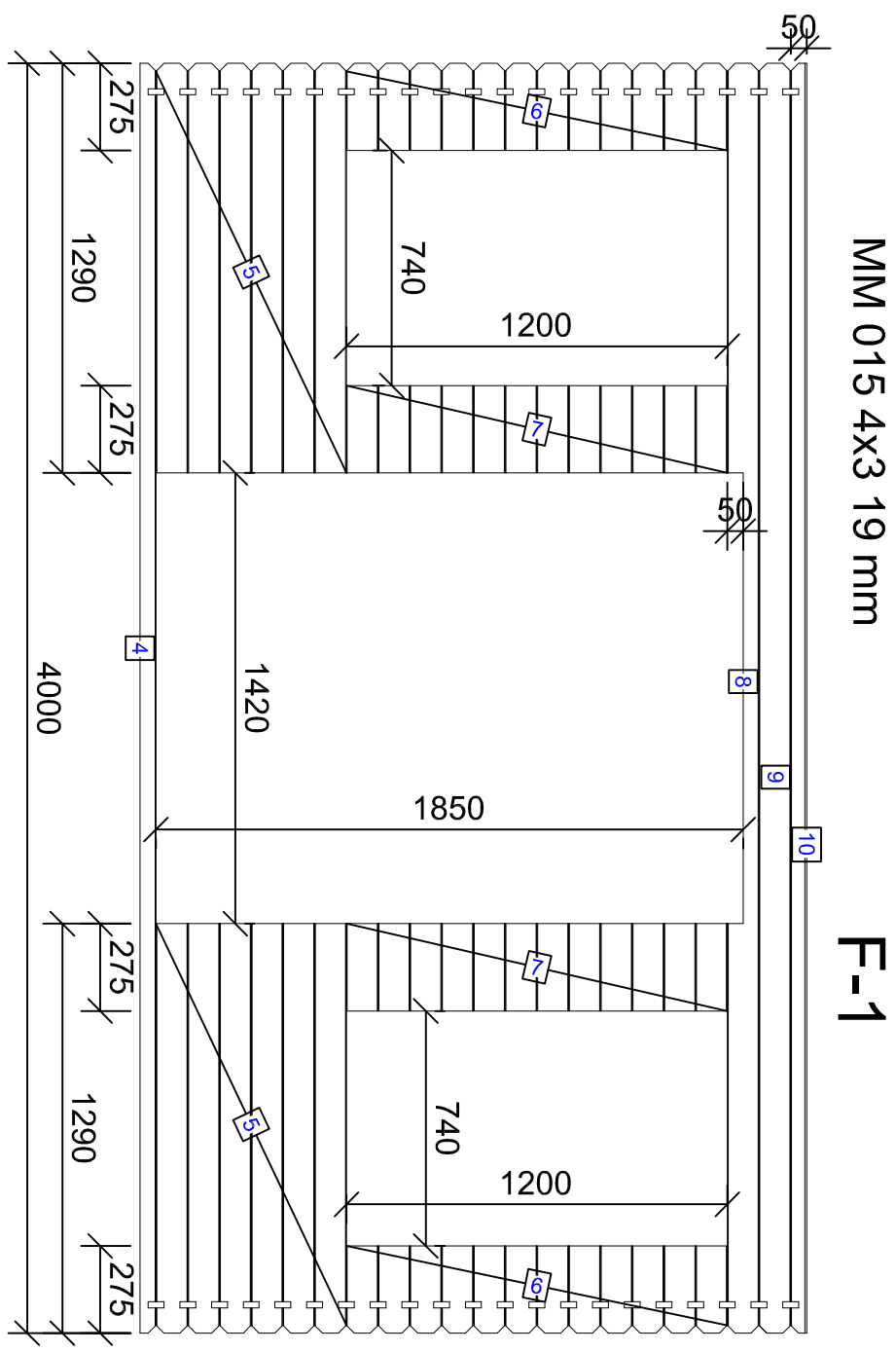

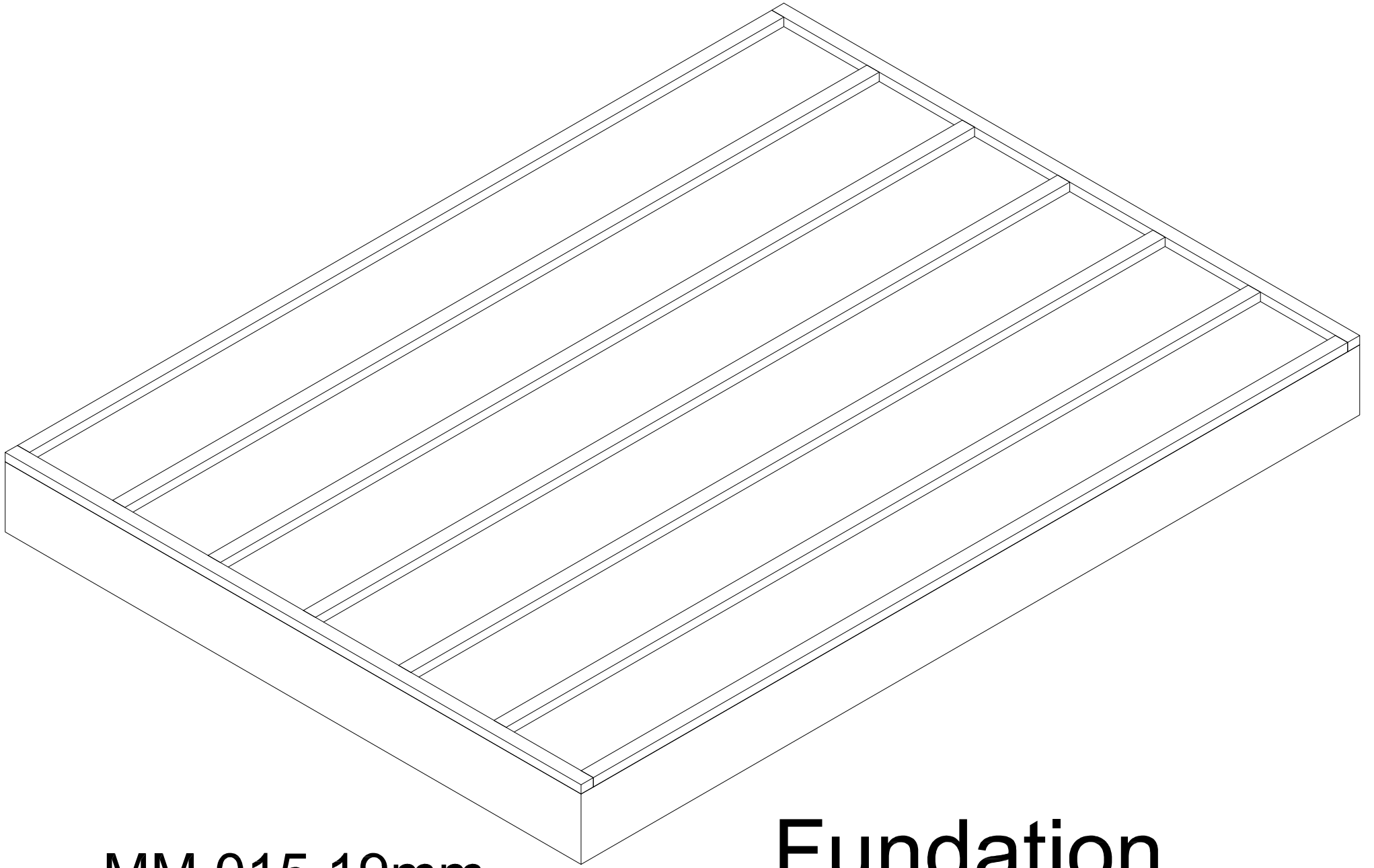

MM 015 19mm
4000x3000mm

Foundation

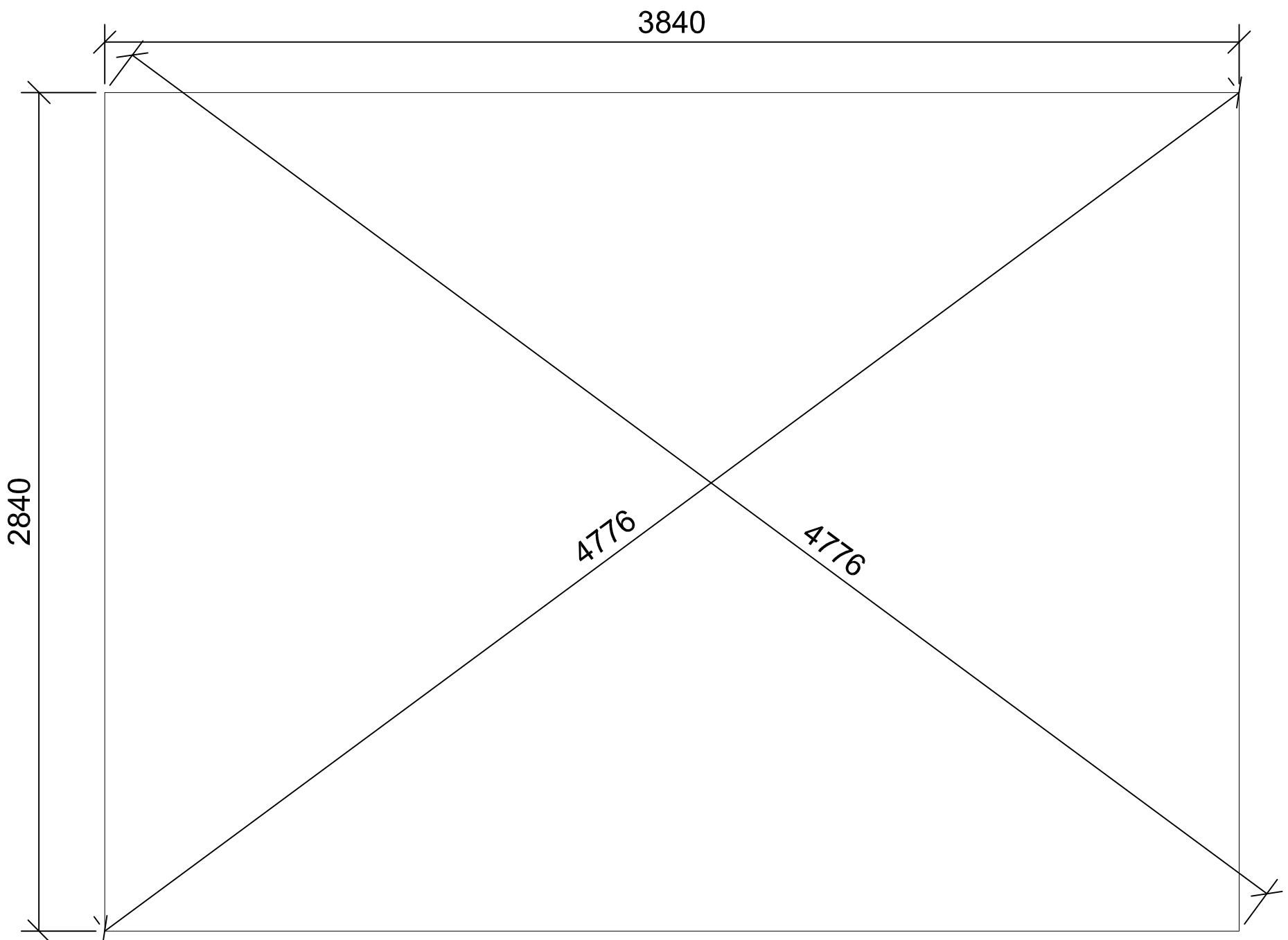

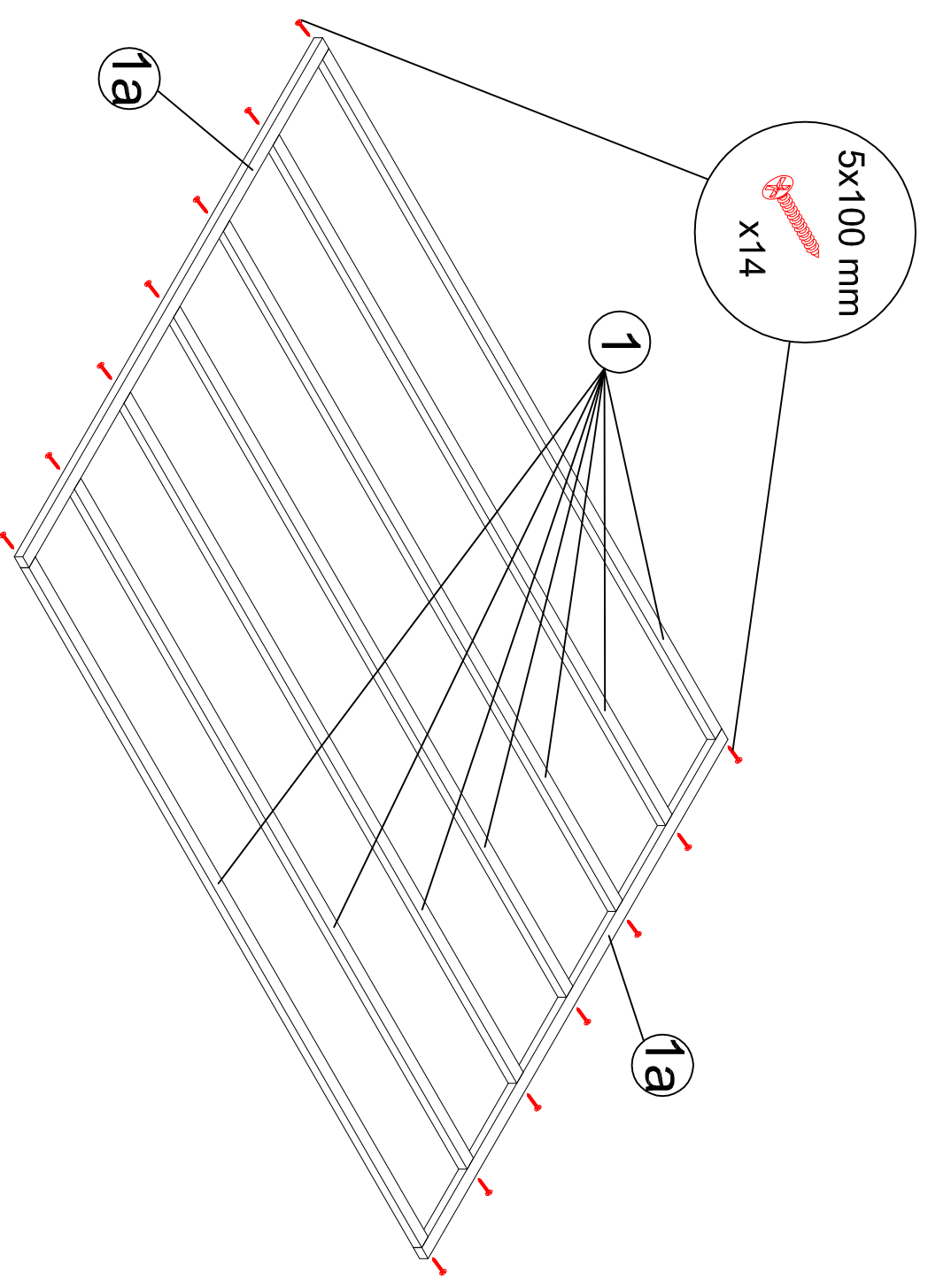
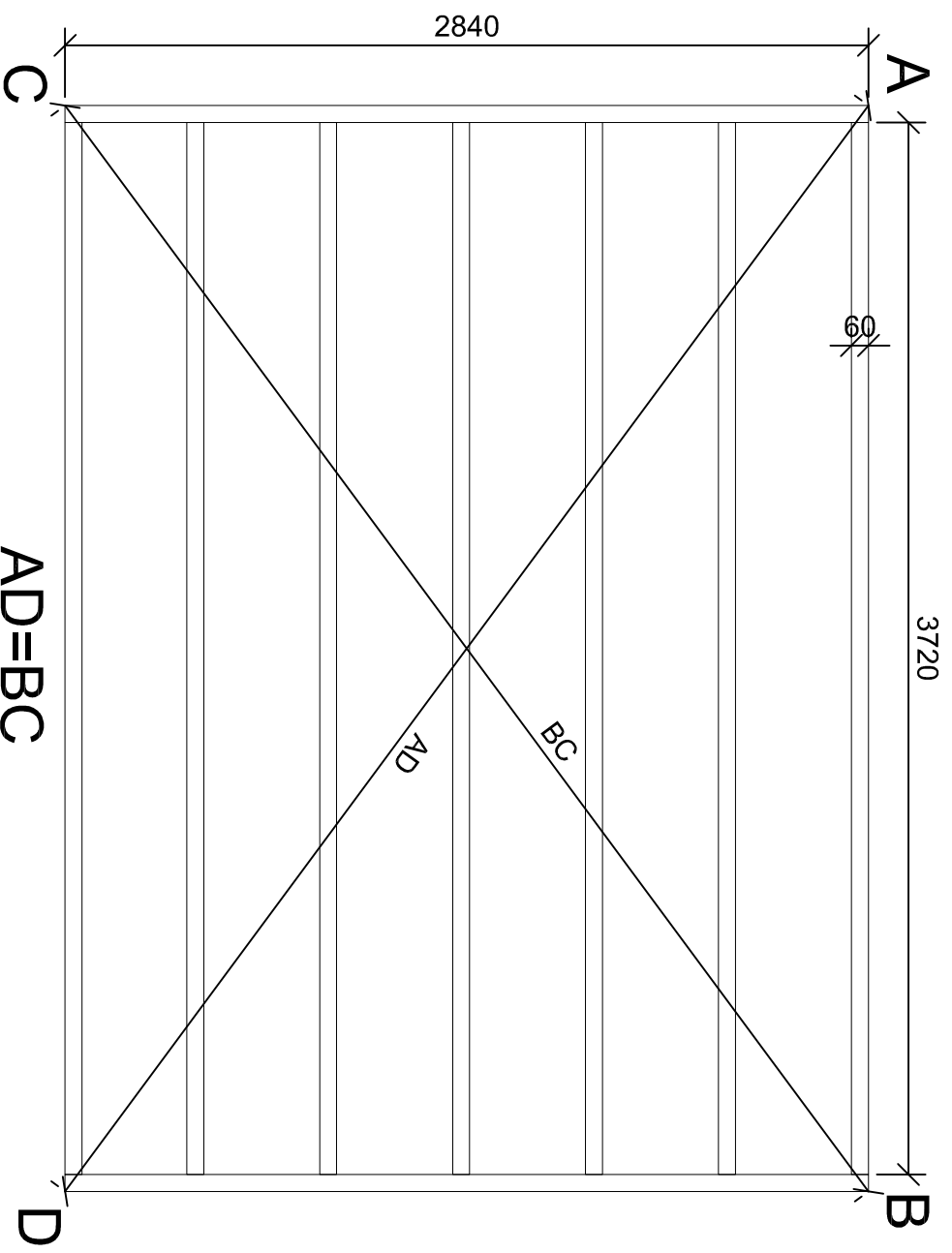

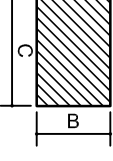
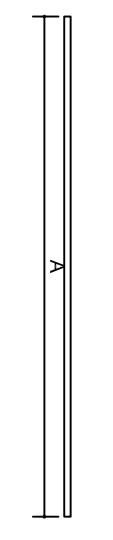
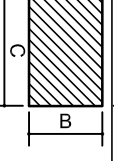
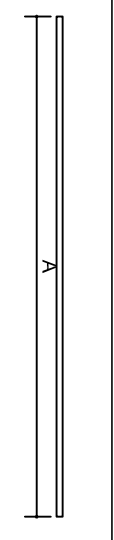
MM 015 4X3	400x300 cm			BE 2015	Date:	
	19 mm 2015.06.05					
Degree <math><74^\circ</math>	Dimensions, mm		Pos.	Quantity		
	A	B				C
	3720	40				60
		2840	40	60	1a	2
						

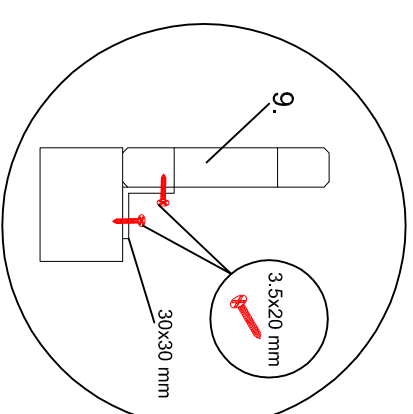
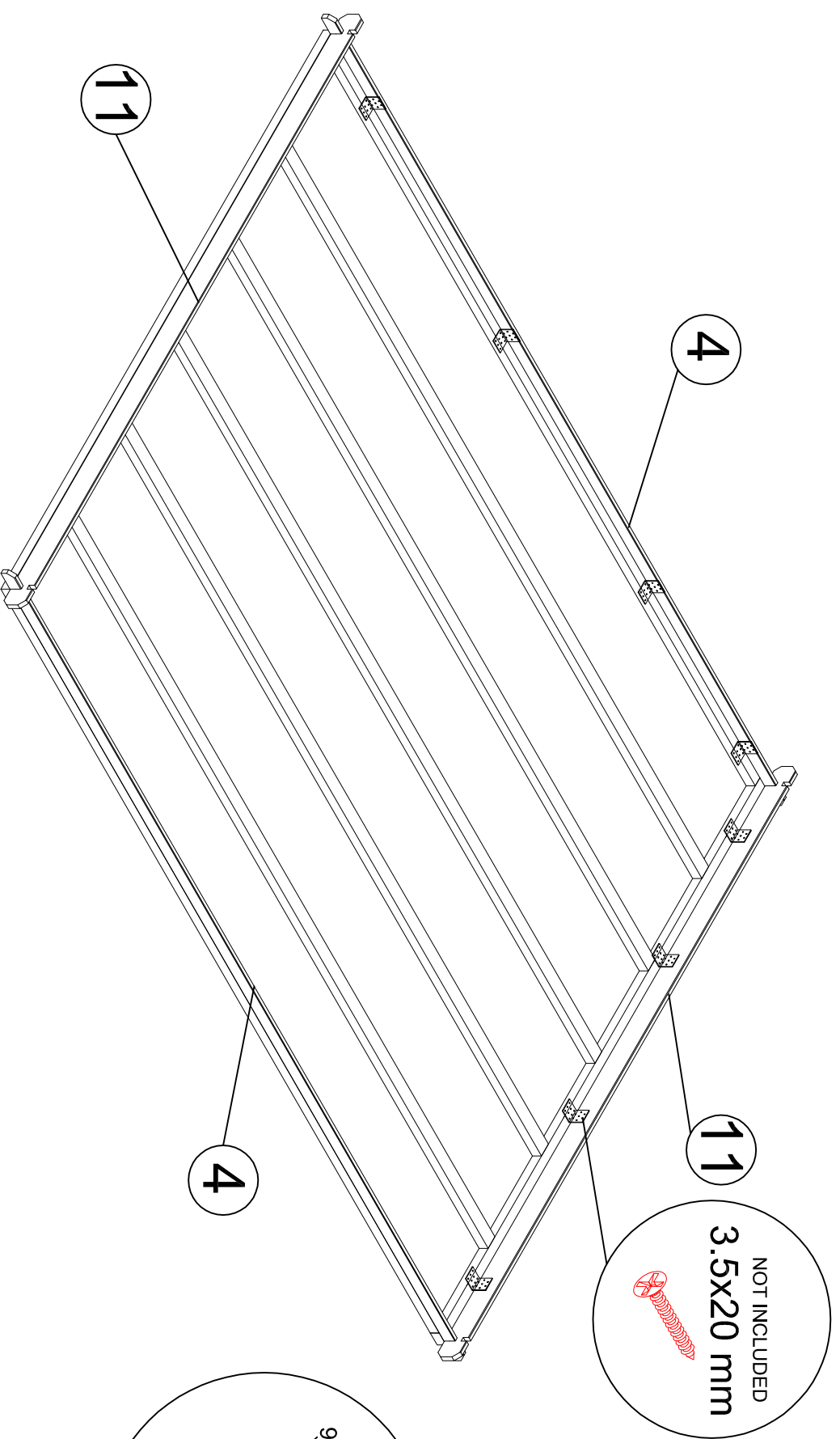

MM 015 4X3

400x300 cm
19 mm 2015.06.05

BE 2015

İtalya

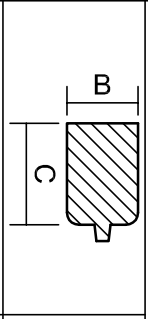
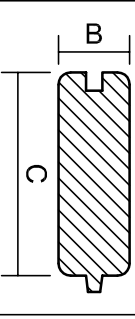
Degree <math><74^\circ</math>	Dimensions, mm			Pos.	Quantity
	A	B	C		
	4000	19	50	4	2
	3000	19	100	11	28

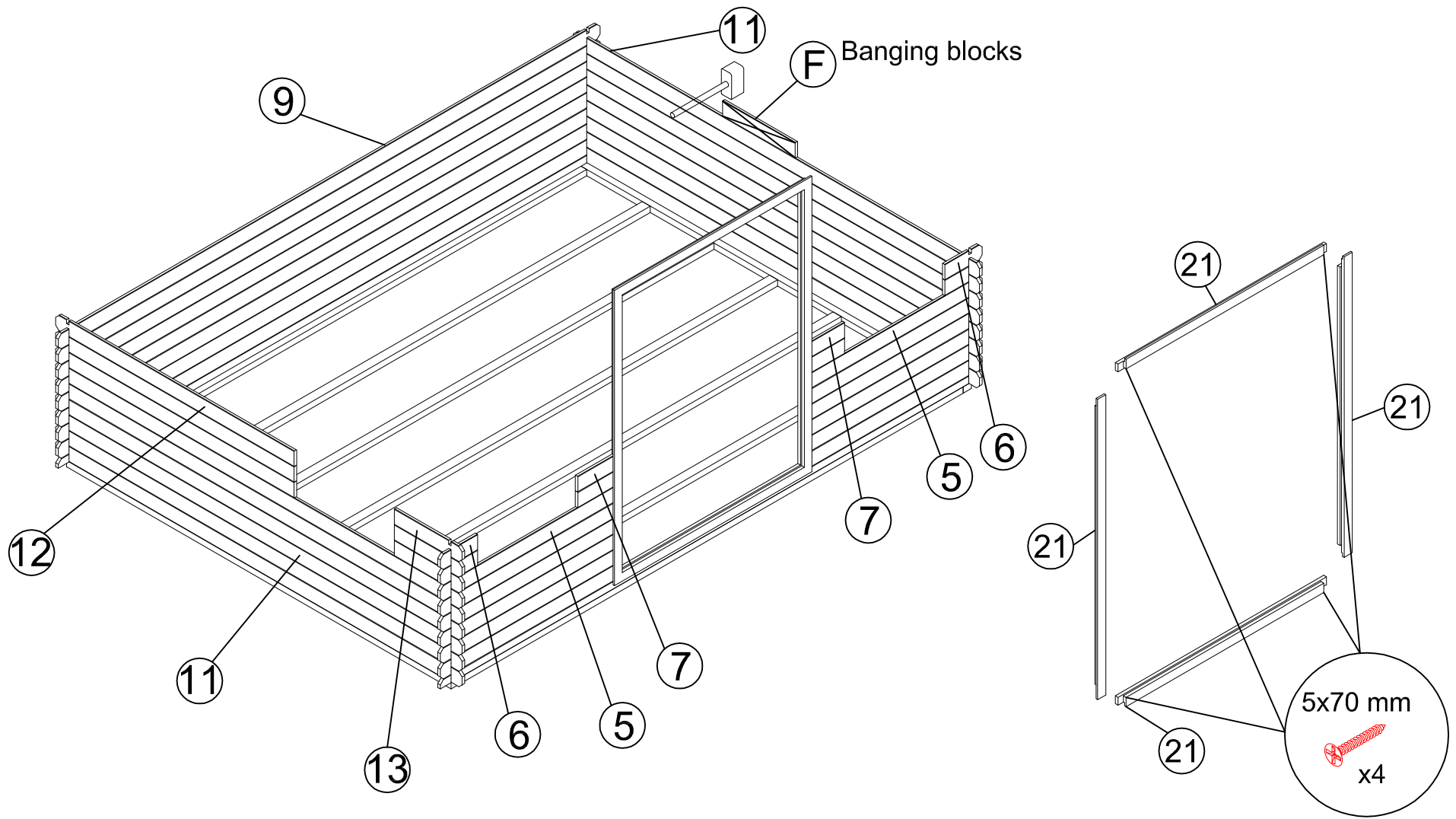

MM 015 4x3		400x300 cm			BE 2015	-Date-	
		19 mm 2015.06.05					
Degree <74°	Dimensions, mm			Pos.	Quantity	-Packing No.-	
	A	B	C				
		1290	19	100	5		12
		275	19	100	6		24
		275	19	100	7		24
		4000	19	100	9		21
		3000	19	100	11		28
		1760	19	100	12		12
		500	19	100	13	12	
		1420	1850		21	1	
		300	19	100	F	6 banging blocks	

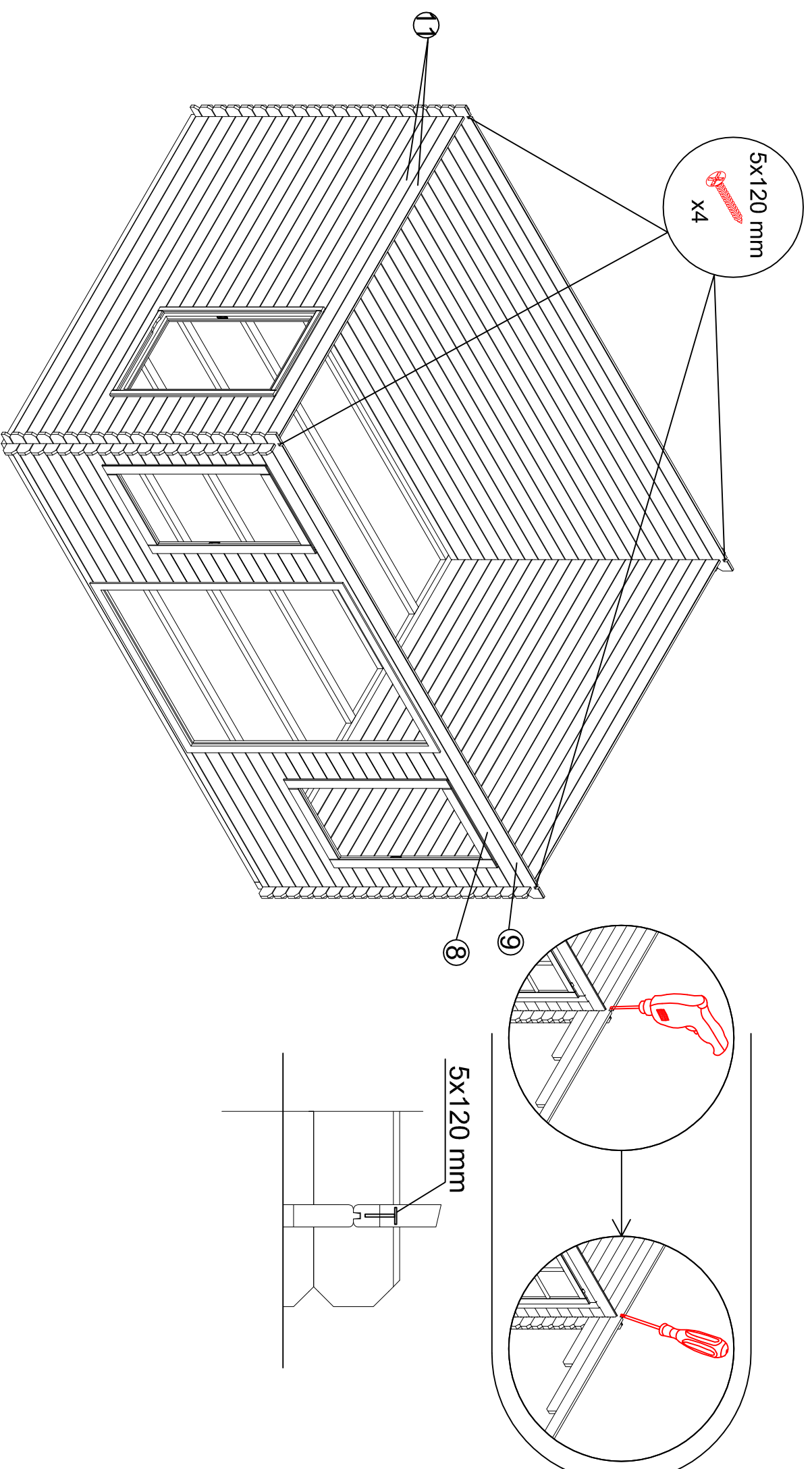

MM 015 4X3

400x300 cm
19 mm 2015.06.05

BE 2015

-Date-

Degree <74°	Dimensions, mm			Pos.	Quantity
	A	B	C		
	4000	19	100	8	1
	4000	19	100	9	21
	3000	19	100	11	28
	740	1200		22	3

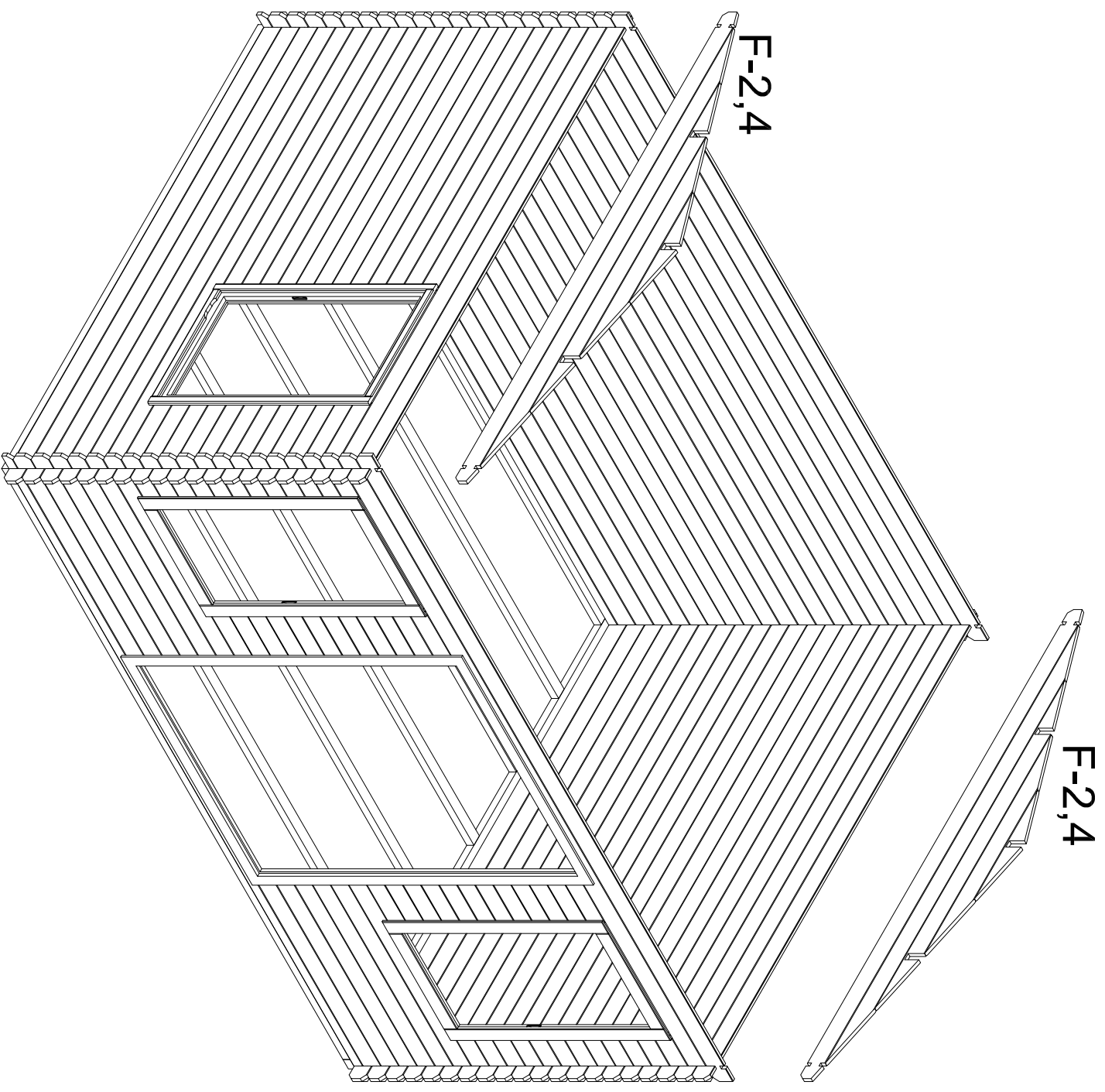

MM 015 4X3

Degree <math><74^\circ</math>

400x300 cm
19 mm 2015.06.05

BE 2015

Date-

Dimensions, mm		Pos.	Quantity
A	B		
3000	494	F-2,4	2

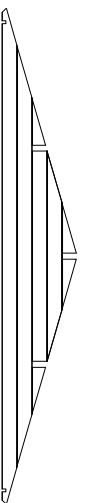

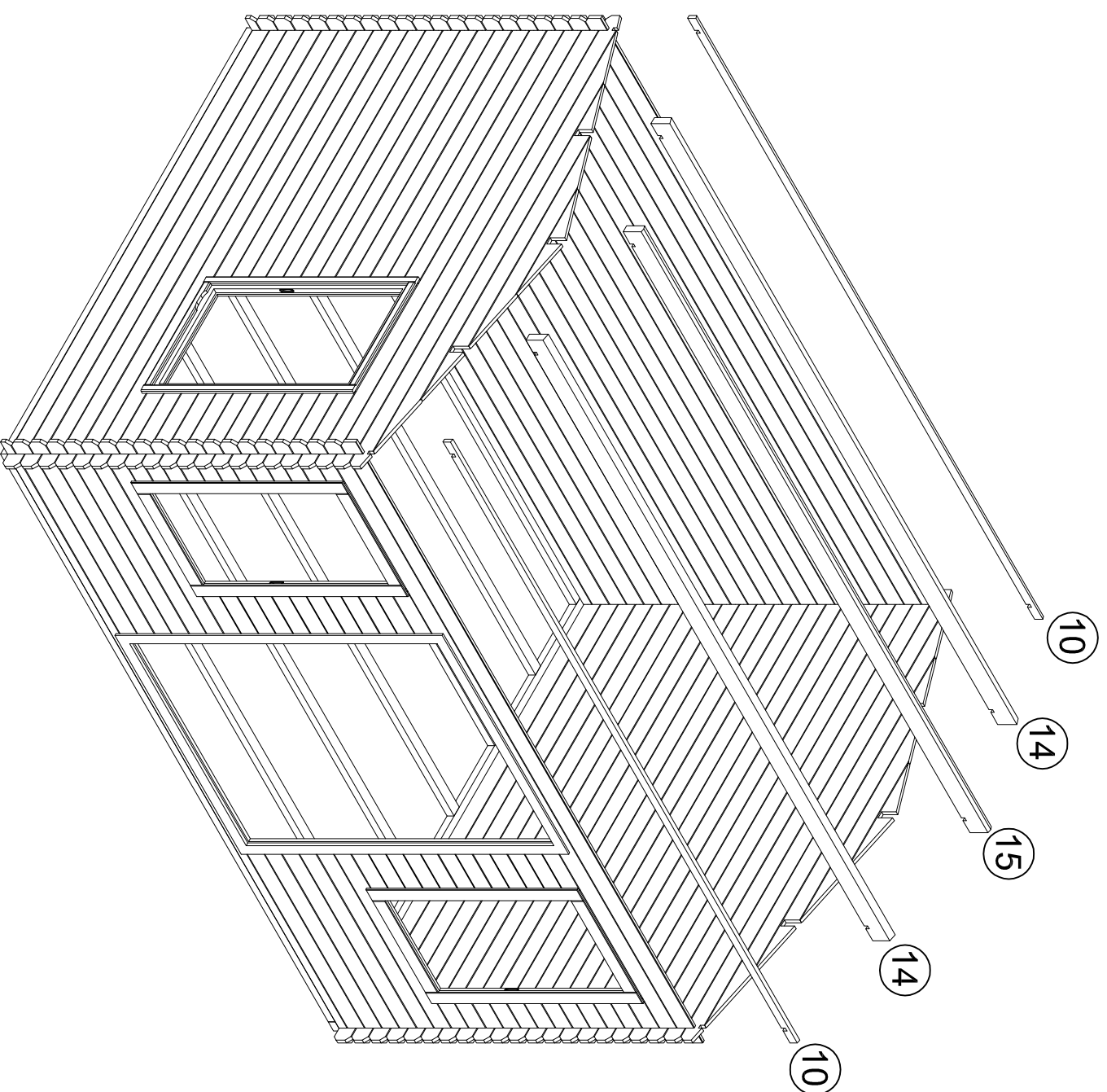

MM 015 4X3

400x300 cm
19 mm 2015.06.05

BE 2015

Дата-

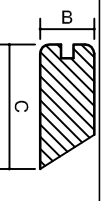
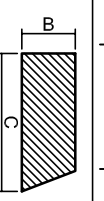
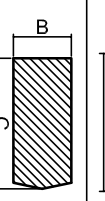
Degree <math><74^\circ</math>	Dimensions, mm			Pos.	Quantity
	A	B	C		
	4000	19	50	10	2
	4000	40	110	14	2
	4000	40	110	15	1

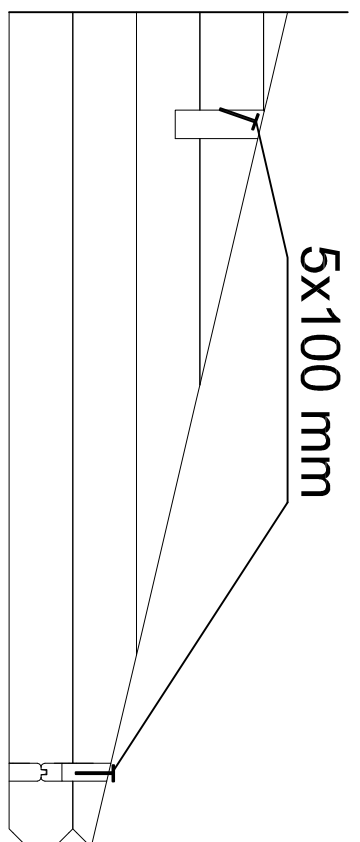
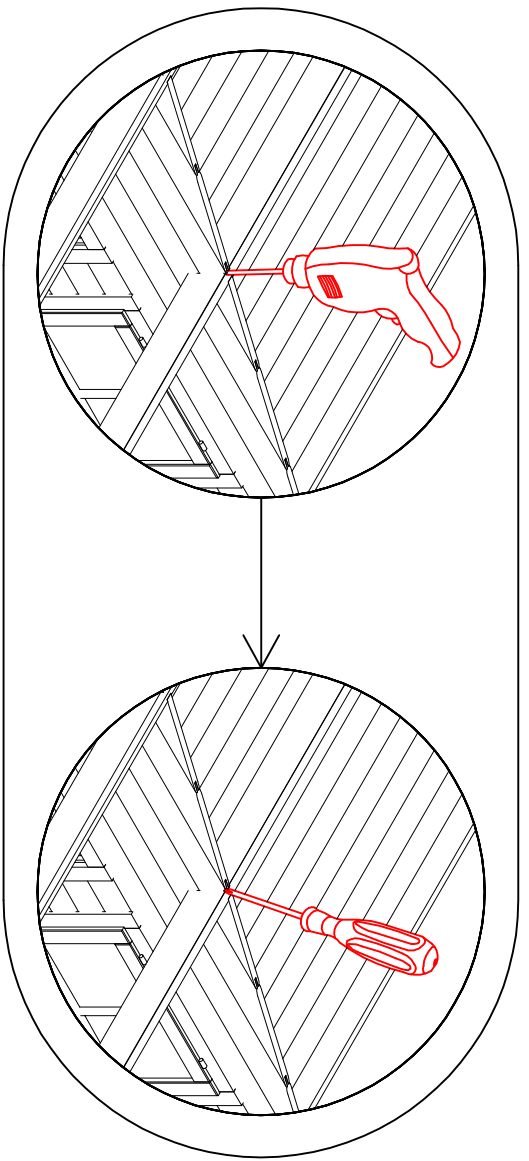
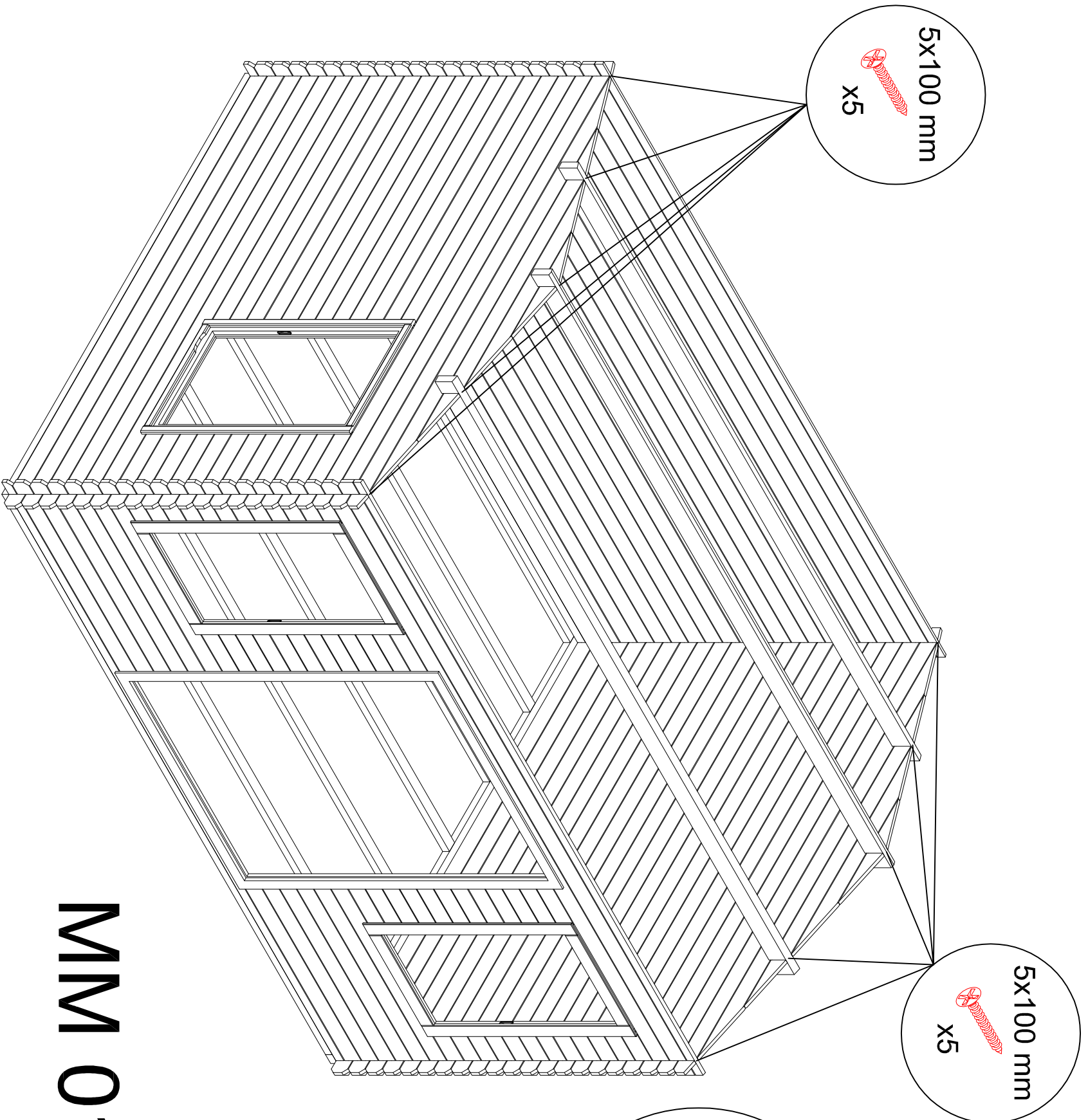

MM 015 4X3

If the last board needs
to be placed lengthwise cut

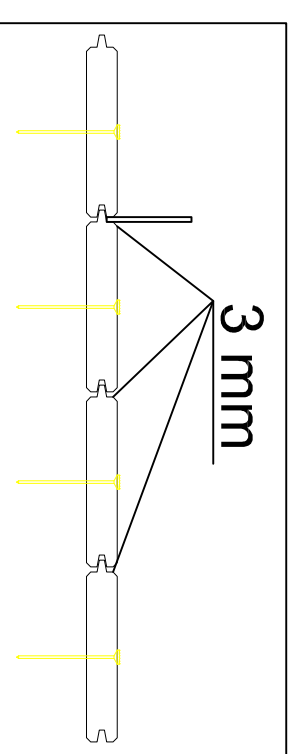
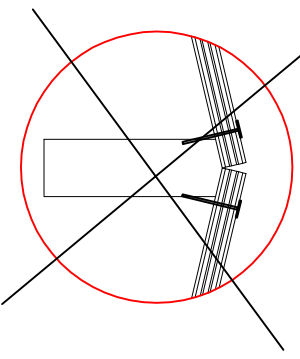
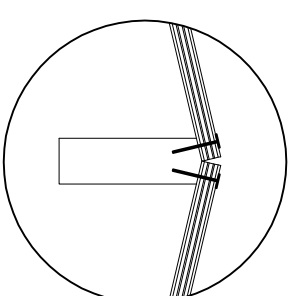
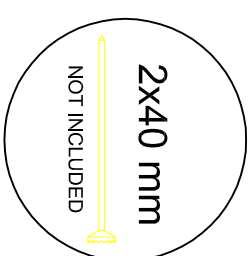
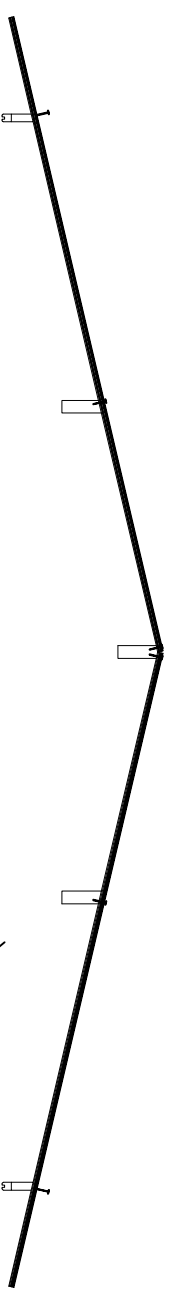
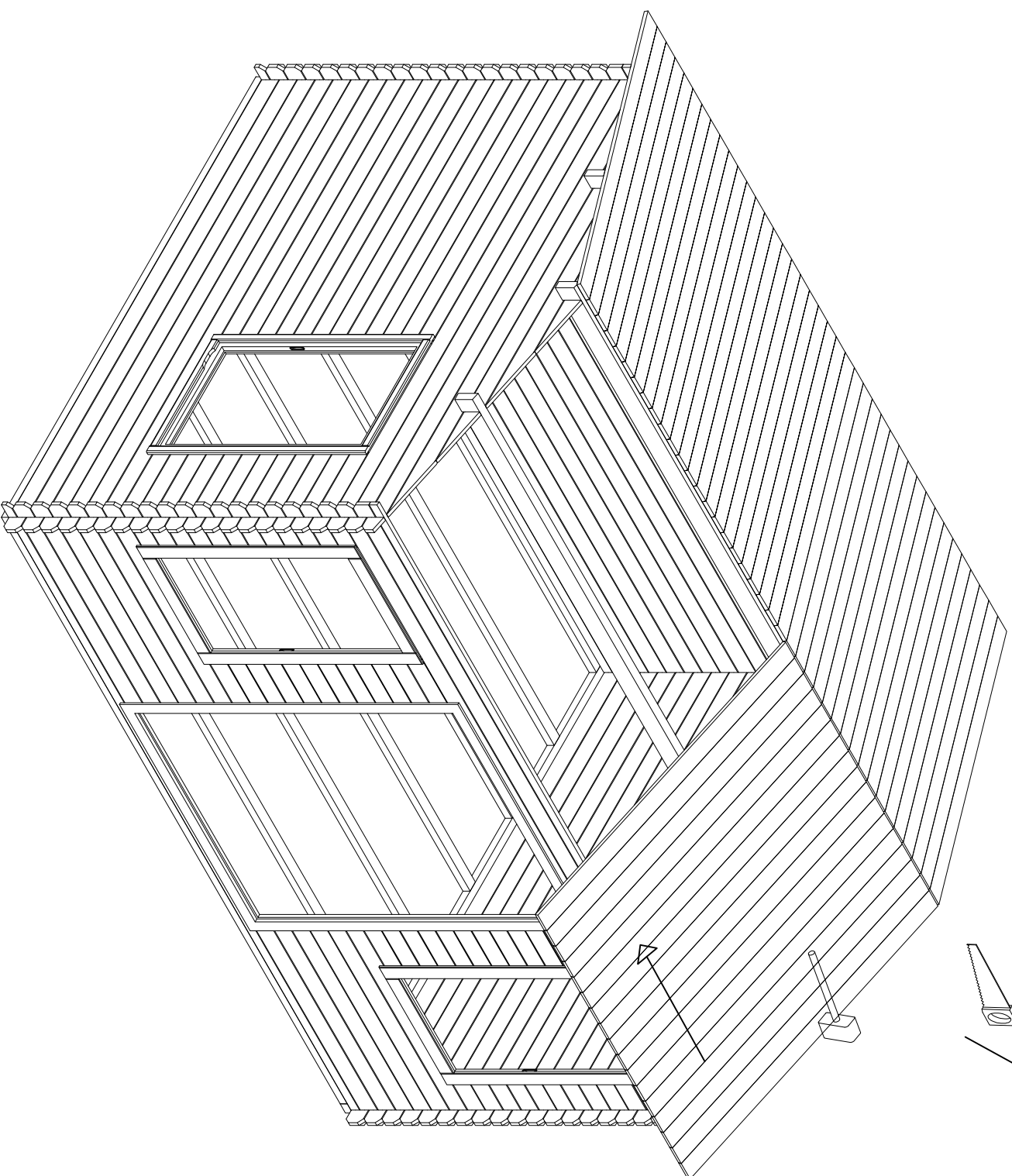

MM 015 4X3

400x300 cm
19 mm 2015.06.05

BE 2015

Date:

Degree <74°

Dimensions, mm

A **B** **C**

Pos.

Quantity

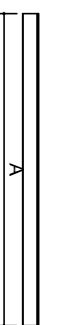
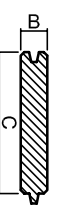

1830

19

100/86

16

80/94

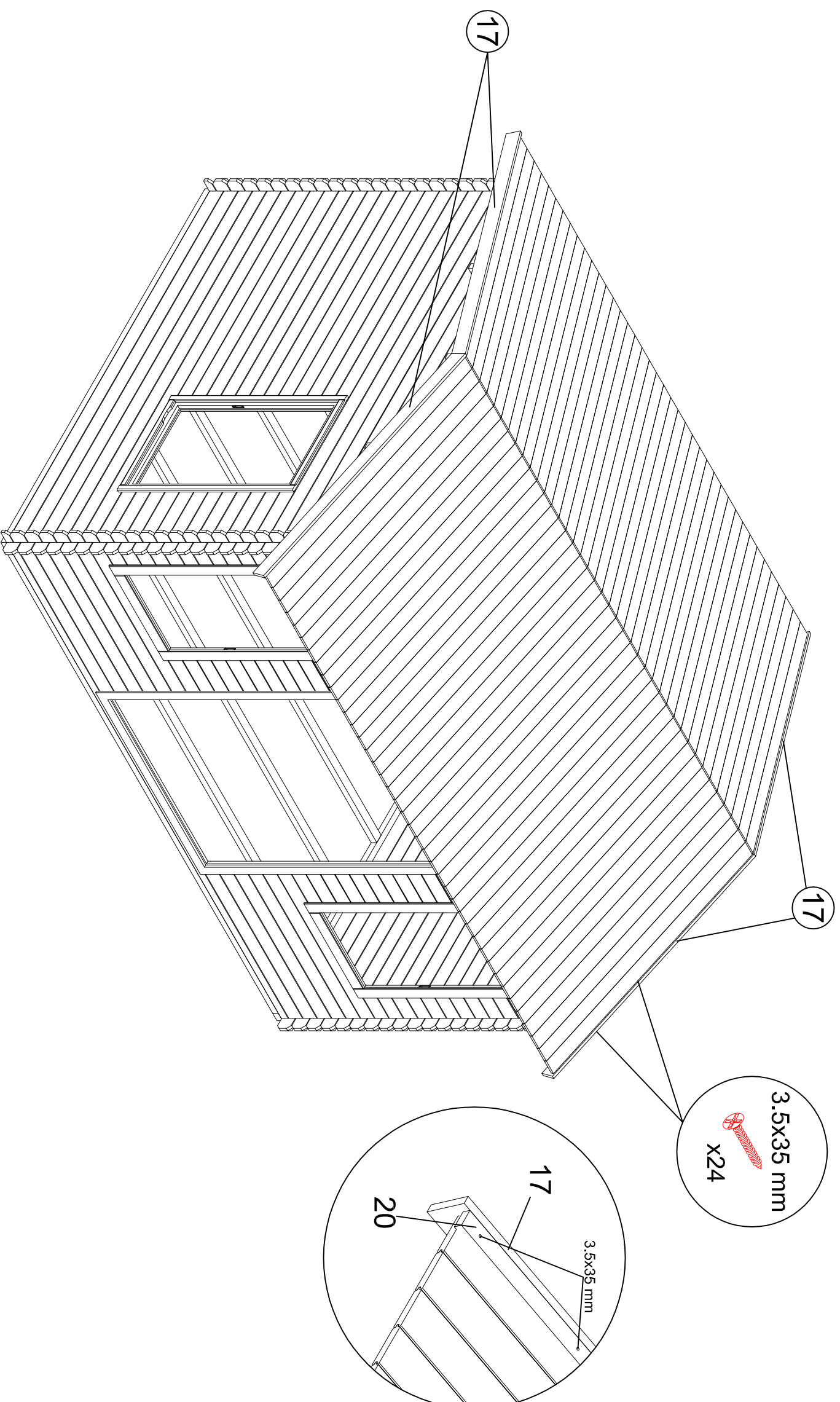

MM 015 4X3

400x300 cm

19 mm 2015.06.05

BE 2015

Date-

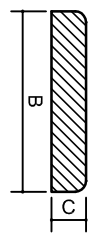
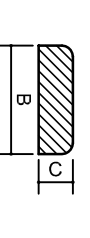
Degree <74°	Dimensions, mm			Pos.	Quantity
	A	B	C		
	1857	19	90	17	4
	1857	19	40	20	4

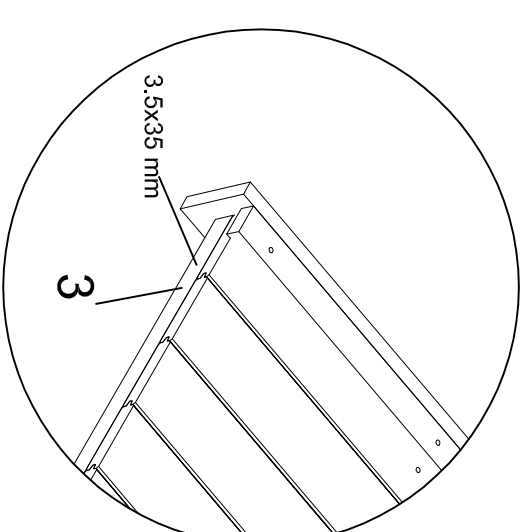
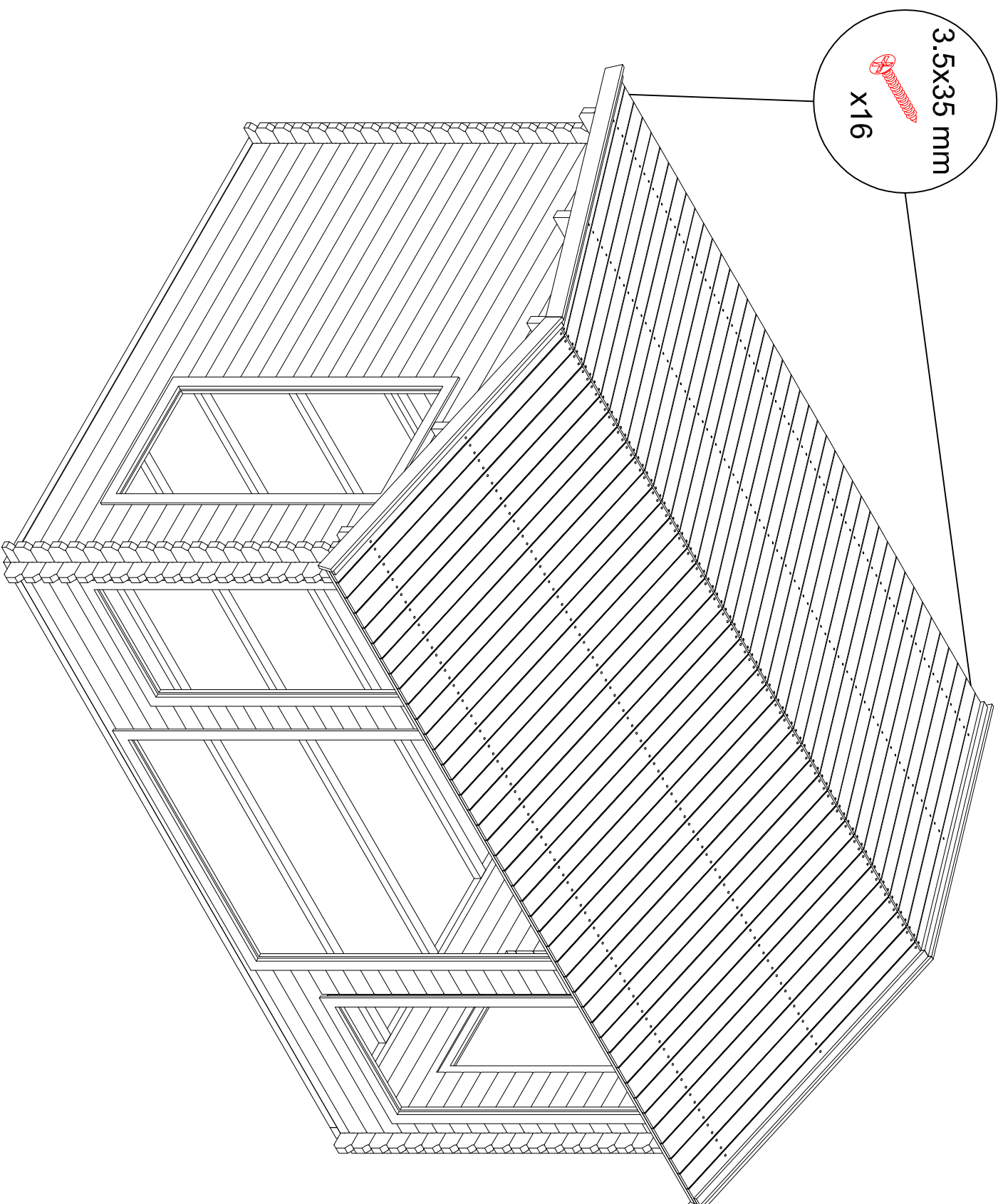

MM 015 4X3		400x300 cm		BE 2015	Date:
		19 mm 2015.06.05			
Degree <math><74^\circ</math>		Dimensions, mm		Pos.	Quantity
		A	B		
		19	24	3	~ 27 meters

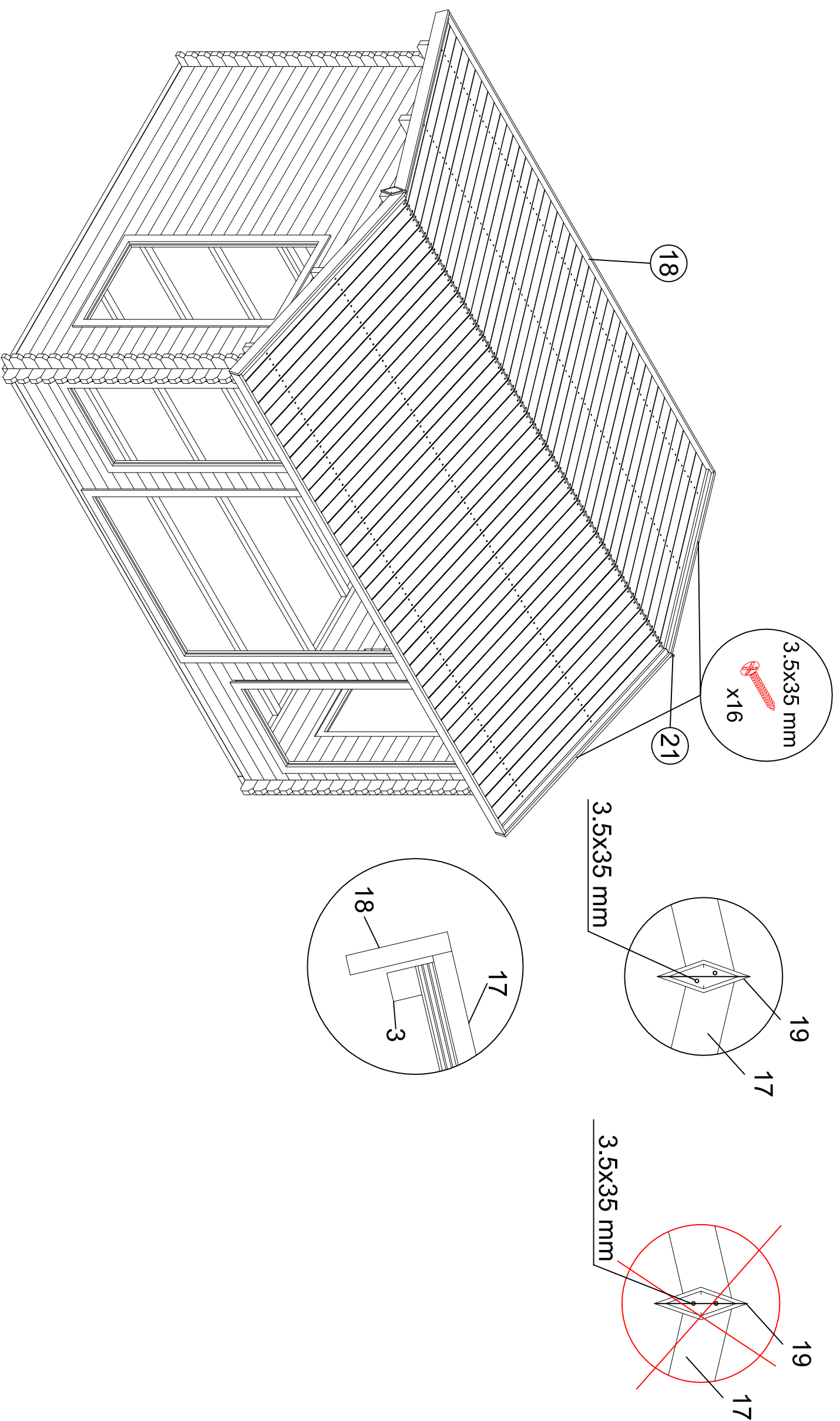

MM 015 4X3

400x300 cm
19 mm 2015.06.05

BE 2015

Date:

Degree <math><74^\circ</math>

Dimensions, mm

Pos.

Quantity

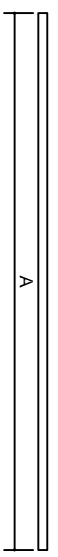
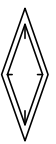
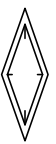
		Dimensions, mm			Pos.	Quantity
		A	B	C		
		2000	19	40	18	4
		200	100		19	2

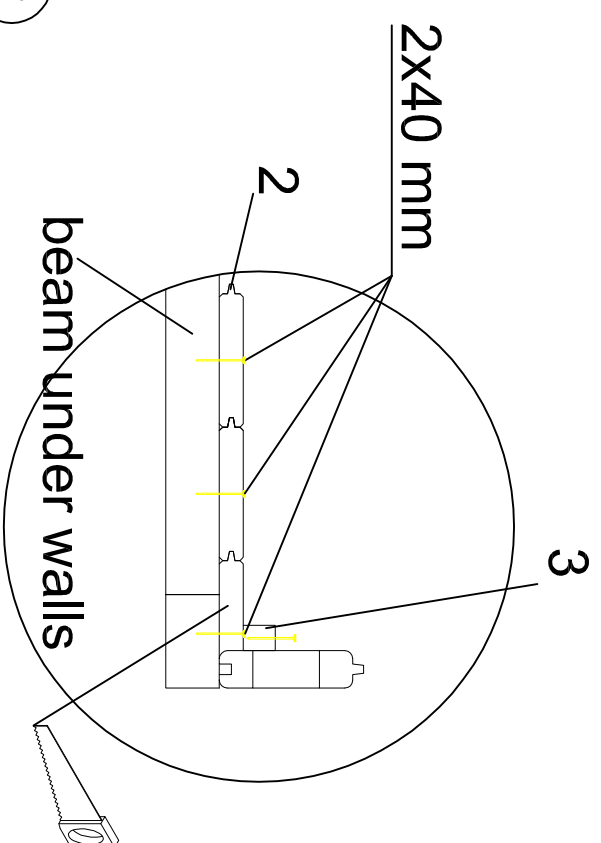
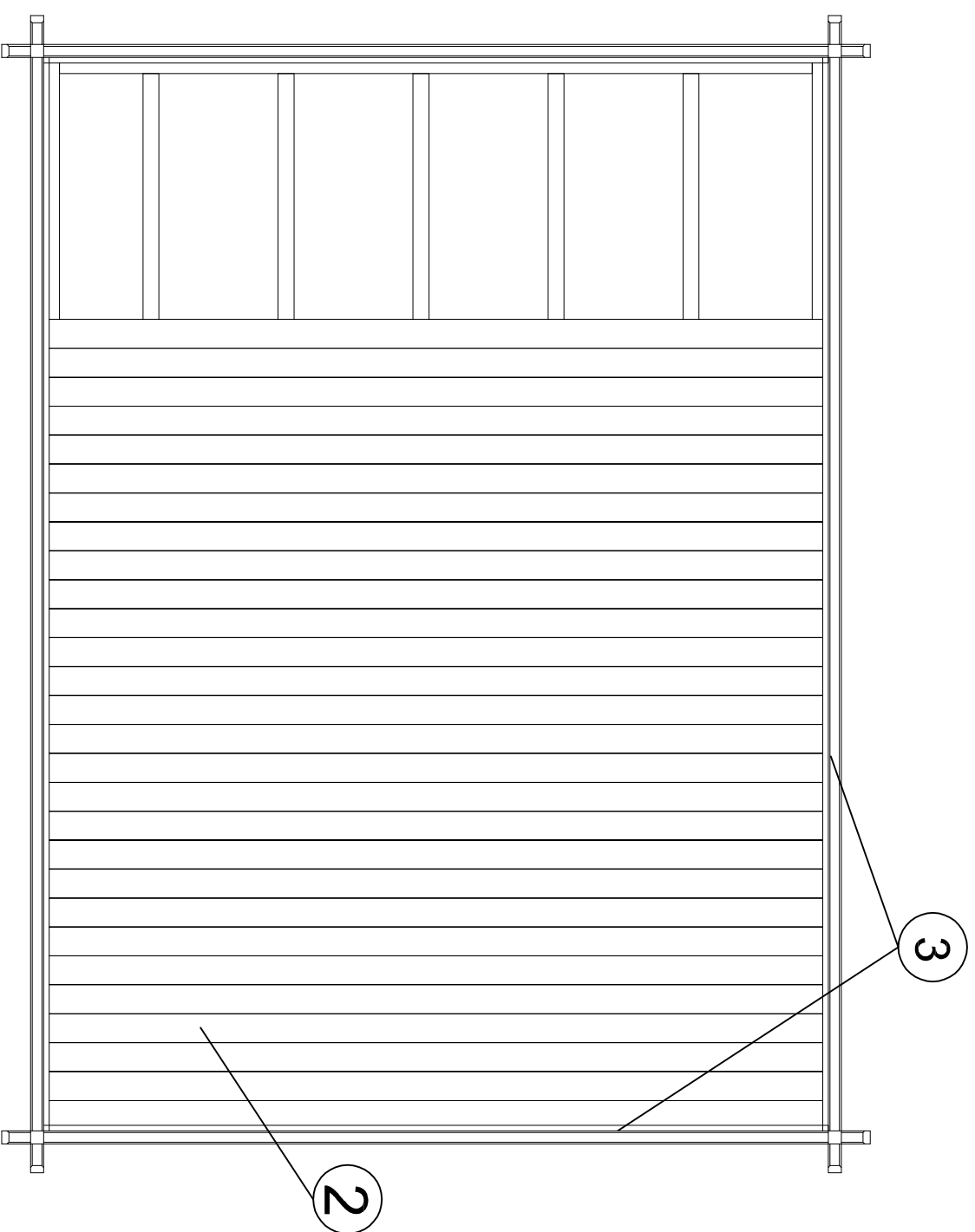

If the last board needs
to be placed lengthwise cut

MM 015 4X3

400x300 cm
19 mm 2015.06.05

BE 2015

DATE

Degree <math><74^\circ</math>

	Dimensions, mm			Pos.	Quantity
	A	B	C		
	2792	19	100/86	2	38/45
	19	19	24	3	~ 27 meters

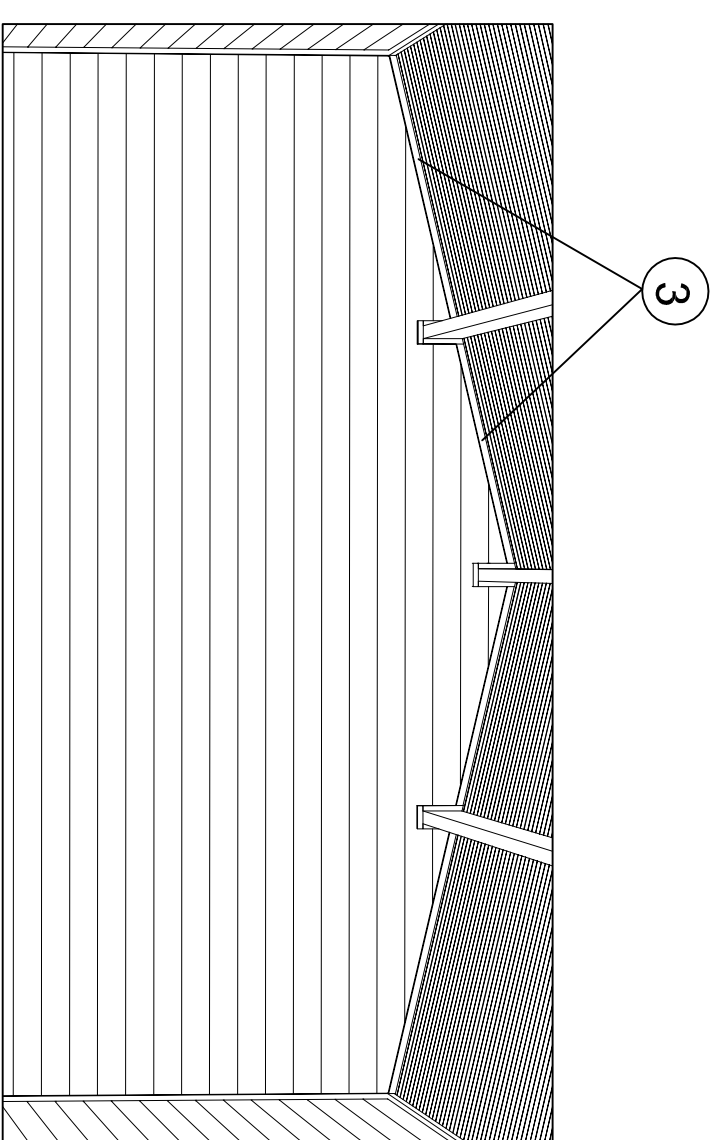
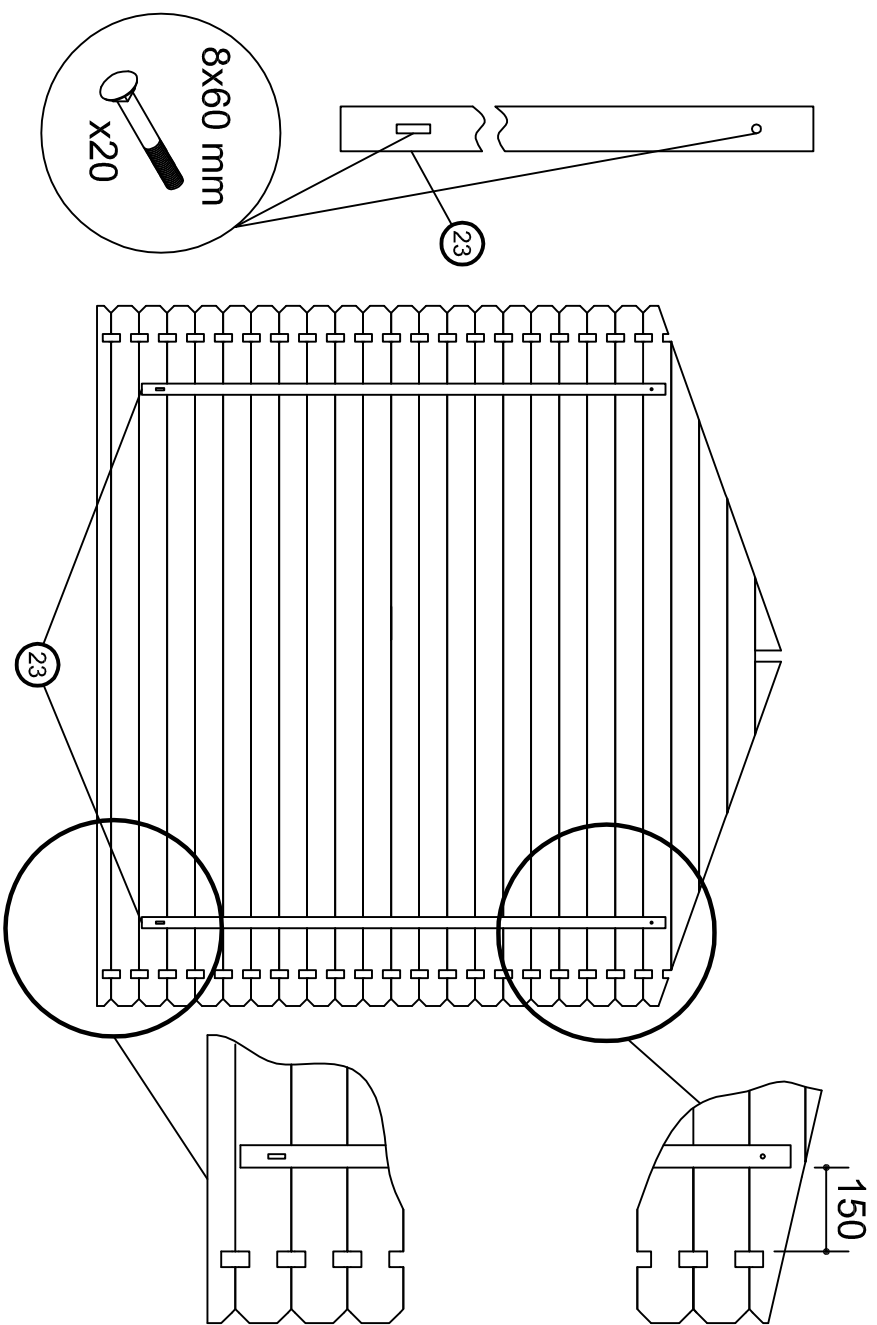

MM 015 4X3

400x300 cm

BE 2015

19 mm 2015.06.05

-Date-

Degree <math><74^\circ</math>

Dimensions, mm

Pos.

Quantity

A

B

C

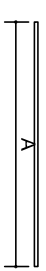

19

24

3

~ 27 meters



1880

19

40

23

4